

NAME: \_\_\_\_\_

DATE: \_\_\_\_\_

Read it.

bake

Color it.

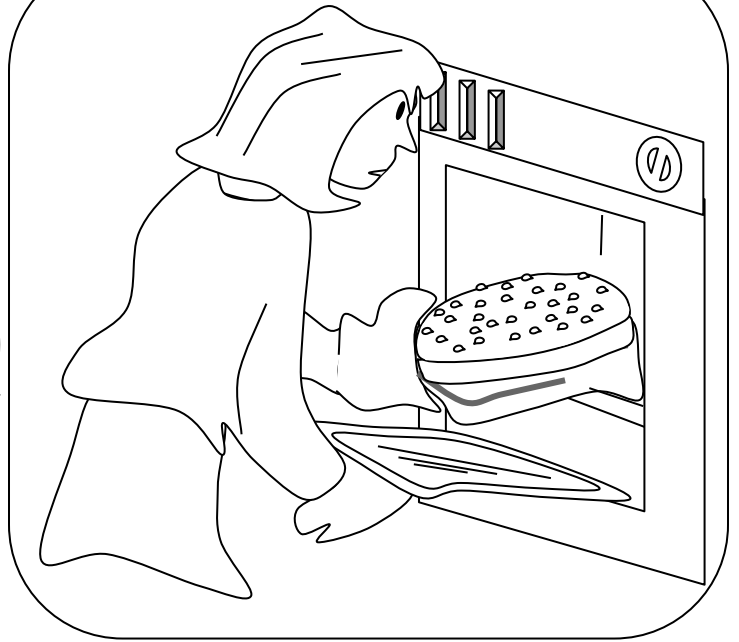

Write it.

a

ake

bake

Blank handwriting practice lines consisting of a solid top line, a dashed middle line, and a solid bottom line.

NAME: \_\_\_\_\_

DATE: \_\_\_\_\_

Read it.

Draw it.

bake

Write it.

a

ake

bake

NAME: \_\_\_\_\_

DATE: \_\_\_\_\_

Read it.

rake

Color it.

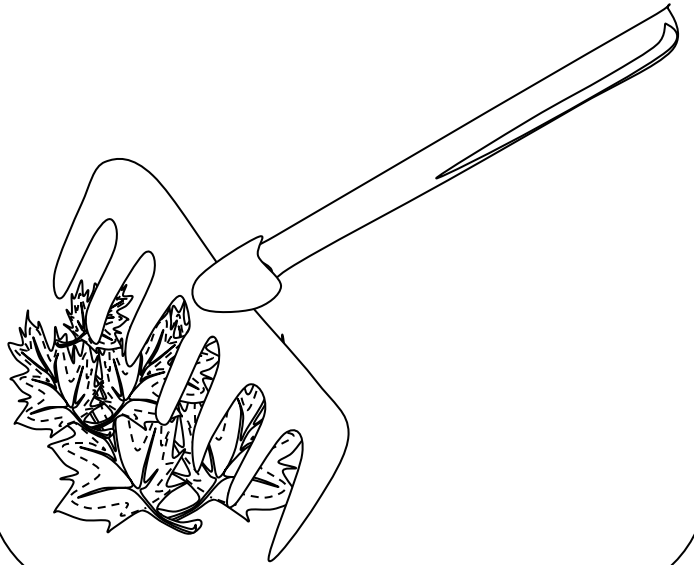

Write it.

a

ake

rake

Blank handwriting practice lines consisting of a solid top line, a dashed middle line, and a solid bottom line.

NAME: \_\_\_\_\_

DATE: \_\_\_\_\_

Read it.

Draw it.

rake

Write it.

a

ake

rake

NAME: \_\_\_\_\_

DATE: \_\_\_\_\_

Read it.

lake

Color it.

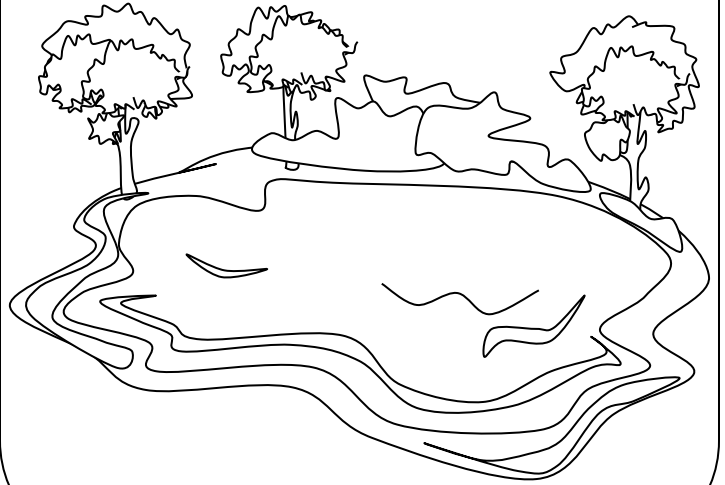

Write it.

a

ake

lake

Blank handwriting practice lines consisting of a solid top line, a dashed middle line, and a solid bottom line.

NAME: \_\_\_\_\_

DATE: \_\_\_\_\_

Read it.

Draw it.

lake

Write it.

a

ake

lake

NAME: \_\_\_\_\_

DATE: \_\_\_\_\_

Read it.

cake

Color it.



Write it.

a

ake

cake

NAME: \_\_\_\_\_

DATE: \_\_\_\_\_

Read it.

Draw it.

cake

Write it.

a

ake

cake



NAME: \_\_\_\_\_

DATE: \_\_\_\_\_

Read it.

cape

Color it.

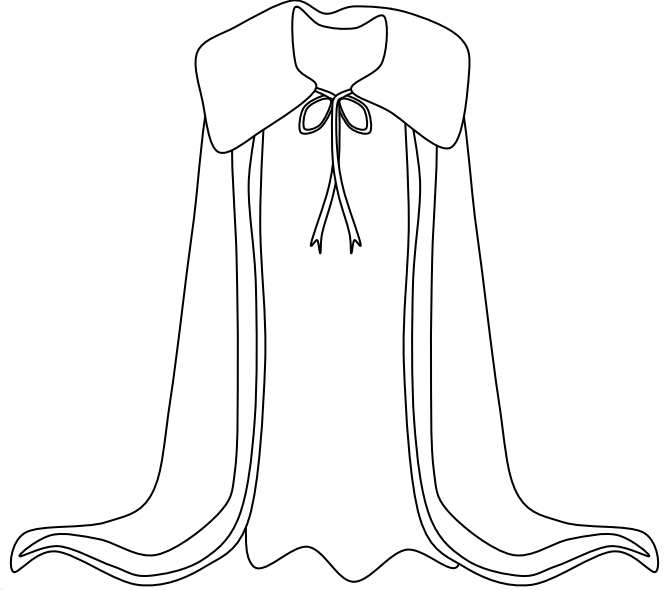

Write it.

a

ape

cape

NAME: \_\_\_\_\_

DATE: \_\_\_\_\_

Read it.

Draw it.

cape

Write it.

a

ape

cape

NAME: \_\_\_\_\_

DATE: \_\_\_\_\_

Read it.

tape

Color it.

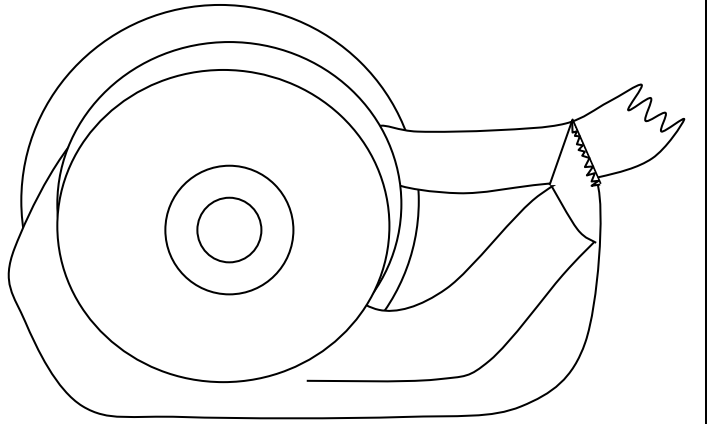

Write it.

a

ape

tape

NAME: \_\_\_\_\_

DATE: \_\_\_\_\_

Read it.

Draw it.

tape

Write it.

a

ape

tape

NAME: \_\_\_\_\_

DATE: \_\_\_\_\_

Read it.

wave

Color it.

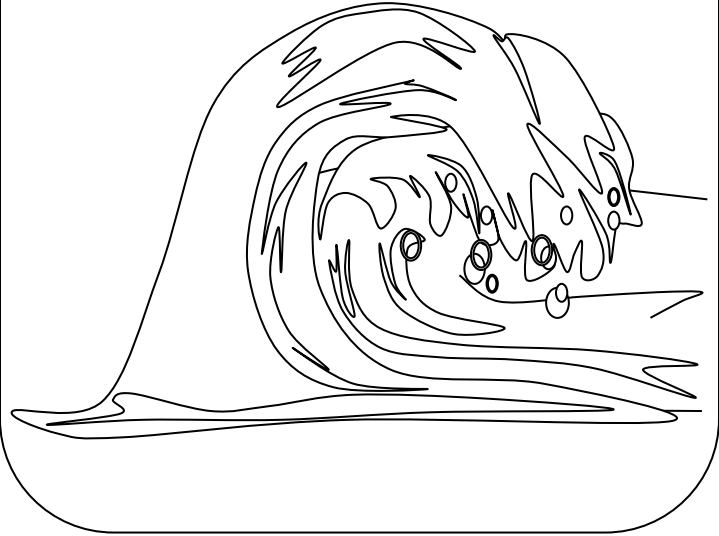

Write it.

w

ave

wave

NAME: \_\_\_\_\_

DATE: \_\_\_\_\_

Read it.

Draw it.

wave

Write it.

w

ave

wave

NAME: \_\_\_\_\_

DATE: \_\_\_\_\_

Read it.

Color it.

cave

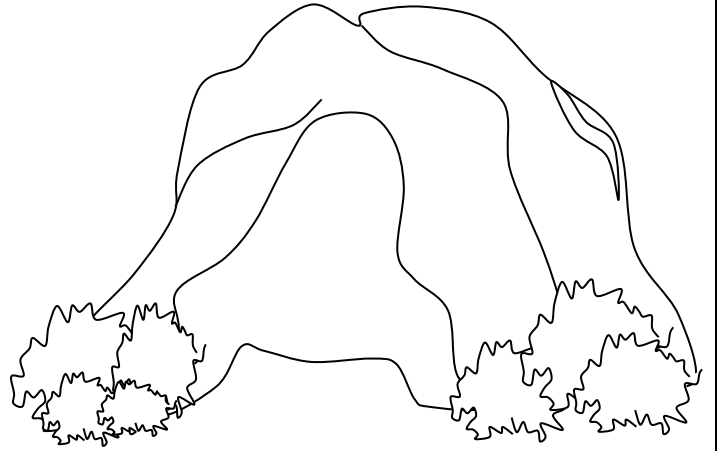

Write it.

a

ave

cave

Blank handwriting lines for independent practice, consisting of a solid top line, a dashed middle line, and a solid bottom line.

NAME: \_\_\_\_\_

DATE: \_\_\_\_\_

Read it.

Draw it.

cave

Write it.

a

ave

cave



NAME: \_\_\_\_\_

DATE: \_\_\_\_\_

Read it.

game

Color it.

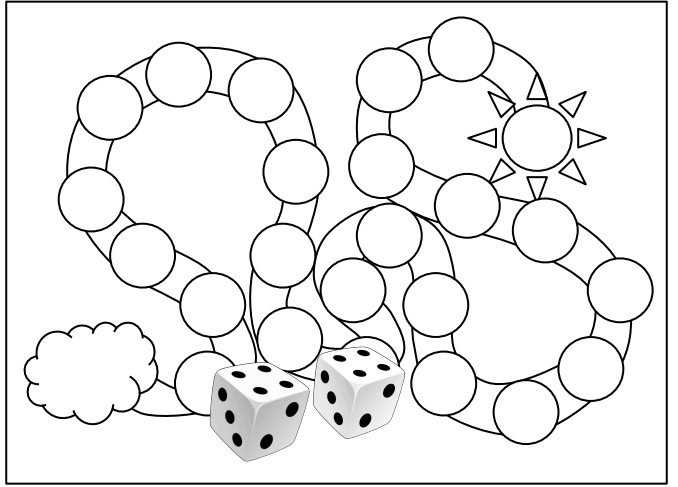

Write it.

a

ame

game

NAME: \_\_\_\_\_

DATE: \_\_\_\_\_

Read it.

Draw it.

game

Write it.

a

ame

game

NAME: \_\_\_\_\_

DATE: \_\_\_\_\_

Read it.

name

Color it.



Write it.

a

ame

name

NAME: \_\_\_\_\_

DATE: \_\_\_\_\_

Read it.

Draw it.

name

Write it.

n

ame

name

NAME: \_\_\_\_\_

DATE: \_\_\_\_\_

Read it.

date

Color it.

DEC

25

Write it.

a

ate

date

NAME: \_\_\_\_\_

DATE: \_\_\_\_\_

Read it.

date

Draw it.

Write it.

a

ate

date

NAME: \_\_\_\_\_

DATE: \_\_\_\_\_

Read it.

gate

Color it.

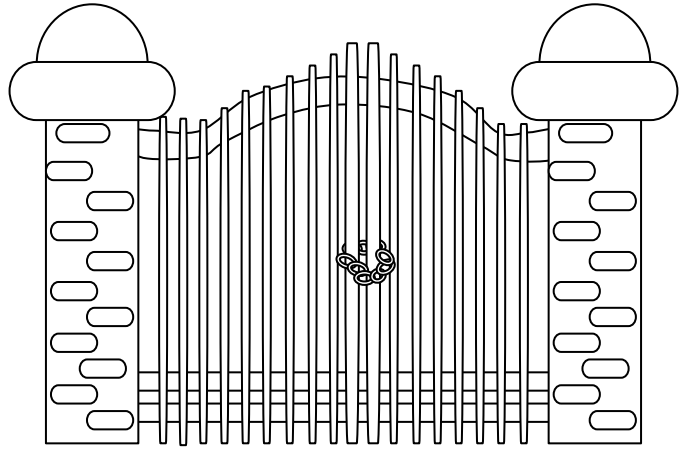

Write it.

a

ate

gate

NAME: \_\_\_\_\_

DATE: \_\_\_\_\_

Read it.

gate

Draw it.

Write it.

a

ate

gate



NAME: \_\_\_\_\_

DATE: \_\_\_\_\_

Read it.

cane

Color it.

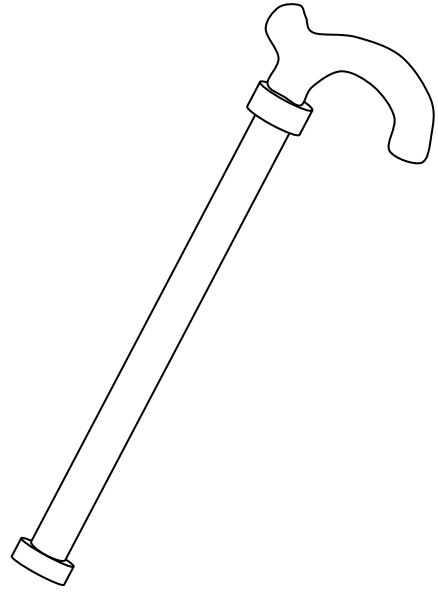

Write it.

a

ane

cane

NAME: \_\_\_\_\_

DATE: \_\_\_\_\_

Read it.

Draw it.

cane

Write it.

a

ane

cane

NAME: \_\_\_\_\_

DATE: \_\_\_\_\_

Read it.

mane

Color it.

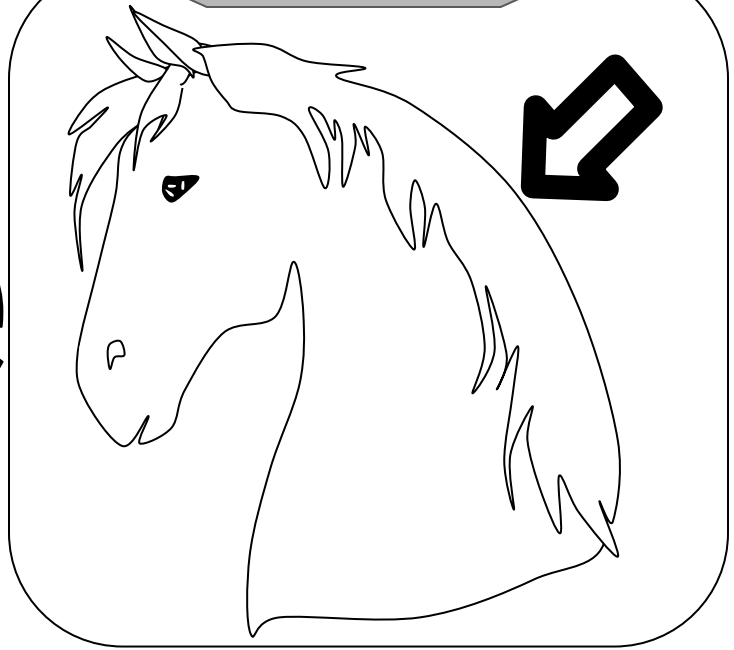

Write it.

a

ane

mane

NAME: \_\_\_\_\_

DATE: \_\_\_\_\_

Read it.

mane

Draw it.

Write it.

a

ane

mane

NAME: \_\_\_\_\_

DATE: \_\_\_\_\_

Read it.

case

Color it.

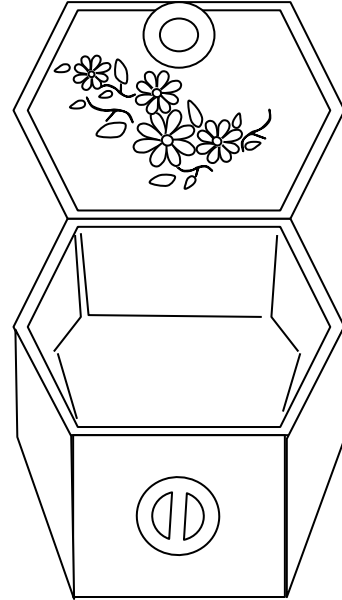

Write it.

a

ase

case

NAME: \_\_\_\_\_

DATE: \_\_\_\_\_

Read it.

Draw it.

case

Write it.

a

ase

case

NAME: \_\_\_\_\_

DATE: \_\_\_\_\_

Read it.

vase

Color it.



Write it.

v

ase

vase

NAME: \_\_\_\_\_

DATE: \_\_\_\_\_

Read it.

Draw it.

vase

Write it.

v

ase

vase



NAME: \_\_\_\_\_

DATE: \_\_\_\_\_

Read it.

line

Color it.

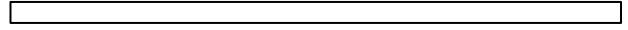

Write it.

Handwriting practice lines for the word "line". Each row consists of a solid top line, a dashed middle line, and a solid bottom line. The first row contains a dotted lowercase letter 'l'. The second row contains a dotted lowercase word 'ine'. The third row contains a dotted lowercase word 'line'. The remaining three rows are blank for independent practice.

NAME: \_\_\_\_\_

DATE: \_\_\_\_\_

Read it.

line

Draw it.

Write it.

i

ine

line

NAME: \_\_\_\_\_

DATE: \_\_\_\_\_

Read it.

nine

Color it.

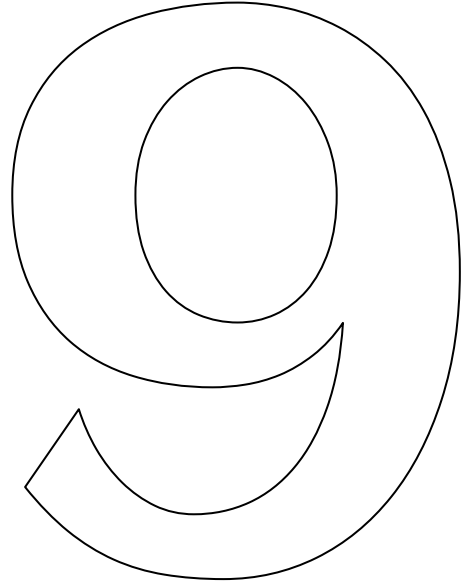

Write it.

i

ine

nine

Blank handwriting practice lines consisting of a solid top line, a dashed middle line, and a solid bottom line.

NAME: \_\_\_\_\_

DATE: \_\_\_\_\_

Read it.

Draw it.

nine

Write it.

i

ine

nine

NAME: \_\_\_\_\_

DATE: \_\_\_\_\_

Read it.

pine

Color it.

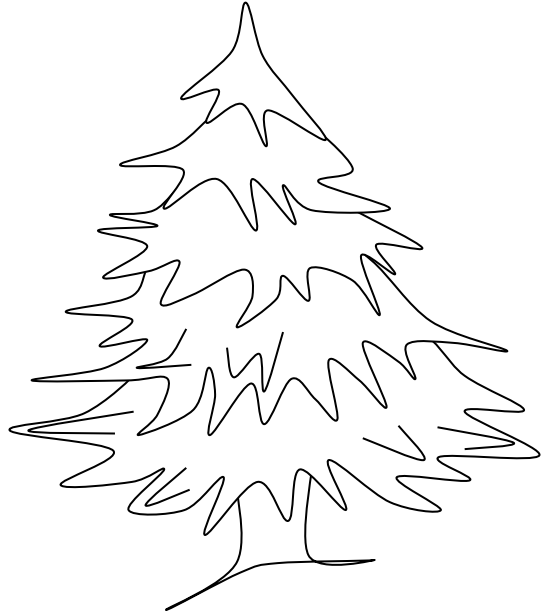

Write it.

i

ine

pine

NAME: \_\_\_\_\_

DATE: \_\_\_\_\_

Read it.

pine

Draw it.

Write it.

i

ine

pine

NAME: \_\_\_\_\_

DATE: \_\_\_\_\_

Read it.

vine

Color it.

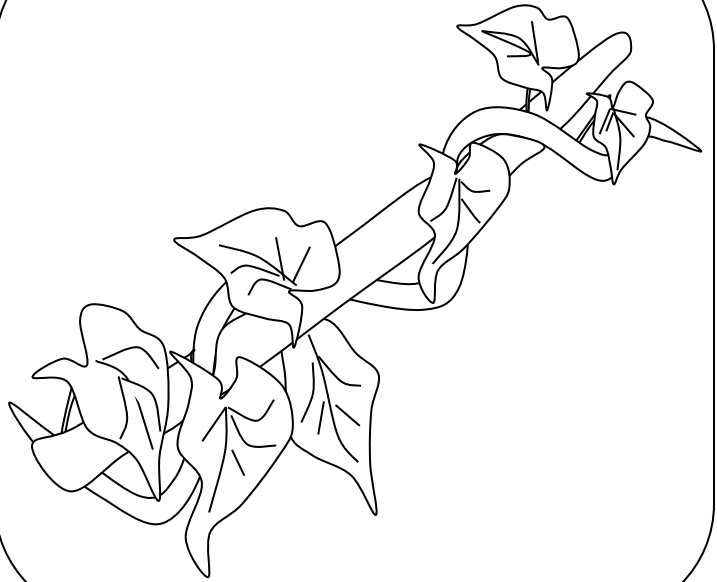

Write it.

i

ine

vine

NAME: \_\_\_\_\_

DATE: \_\_\_\_\_

Read it.

vine

Draw it.

Write it.

i

ine

vine



NAME: \_\_\_\_\_

DATE: \_\_\_\_\_

Read it.

bike

Color it.

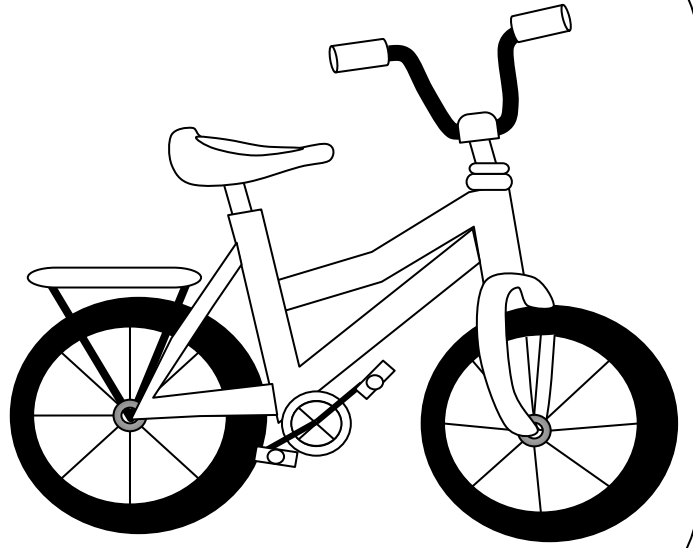

Write it.

i

ike

bike

Blank handwriting practice lines consisting of a solid top line, a dashed middle line, and a solid bottom line.

NAME: \_\_\_\_\_

DATE: \_\_\_\_\_

Read it.

Draw it.

bike

Write it.

i

ike

bike

NAME: \_\_\_\_\_

DATE: \_\_\_\_\_

Read it.

hike

Color it.



Write it.

i

ike

hike

Blank handwriting practice lines consisting of a solid top line, a dashed middle line, and a solid bottom line.

NAME: \_\_\_\_\_

DATE: \_\_\_\_\_

Read it.

Draw it.

hike

Write it.

i

ike

hike

NAME: \_\_\_\_\_

DATE: \_\_\_\_\_

Read it.

lime

Color it.

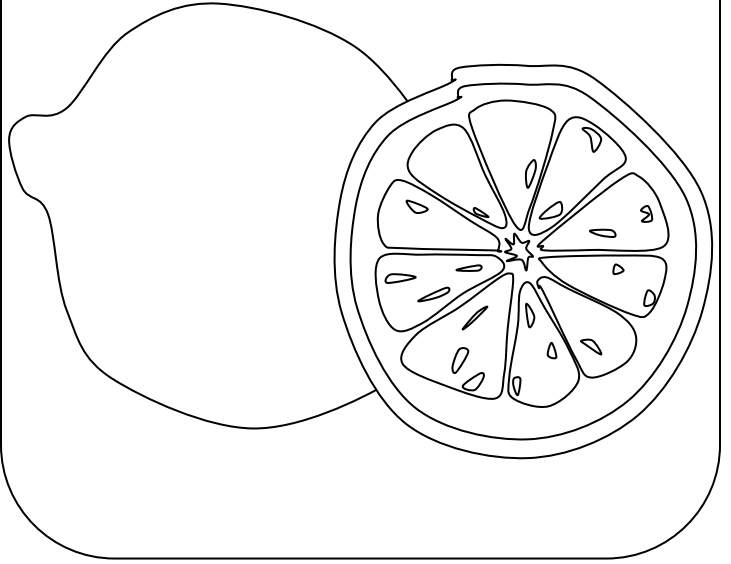

Write it.

i

ime

lime

NAME: \_\_\_\_\_

DATE: \_\_\_\_\_

Read it.

Draw it.

lime

Write it.

i

ime

lime

NAME: \_\_\_\_\_

DATE: \_\_\_\_\_

Read it.

time

Color it.

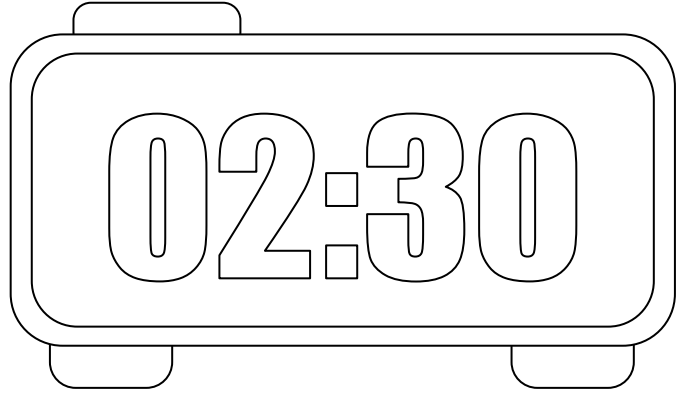

Write it.

i

ime

time

NAME: \_\_\_\_\_

DATE: \_\_\_\_\_

Read it.

Draw it.

time

Write it.

i

ime

time



NAME: \_\_\_\_\_

DATE: \_\_\_\_\_

Read it.

hide

Color it.



Write it.

i

ide

hide

Blank handwriting practice lines consisting of a solid top line, a dashed middle line, and a solid bottom line.

NAME: \_\_\_\_\_

DATE: \_\_\_\_\_

Read it.

Draw it.

hide

Write it.

i

ide

hide

Blank handwriting practice lines consisting of a solid top line, a dashed middle line, and a solid bottom line.

NAME: \_\_\_\_\_

DATE: \_\_\_\_\_

Read it.

ride

Color it.

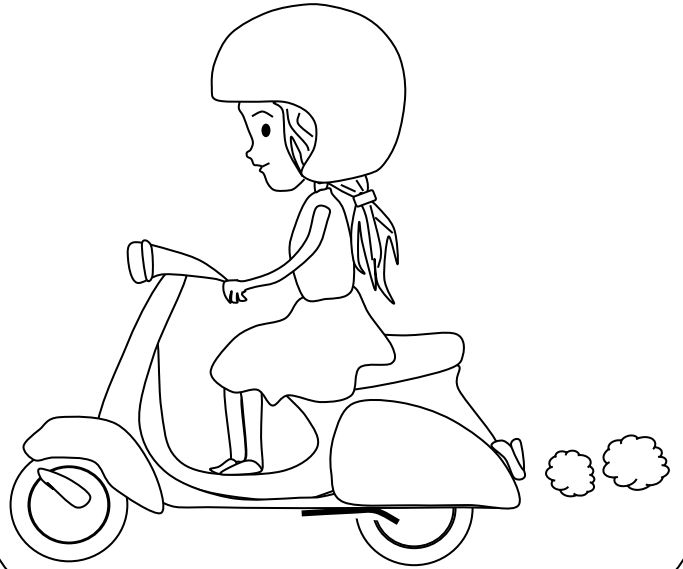

Write it.

i

ide

ride

NAME: \_\_\_\_\_

DATE: \_\_\_\_\_

Read it.

ride

Draw it.

Write it.

i

ide

ride

NAME: \_\_\_\_\_

DATE: \_\_\_\_\_

Read it.

pipe

Color it.

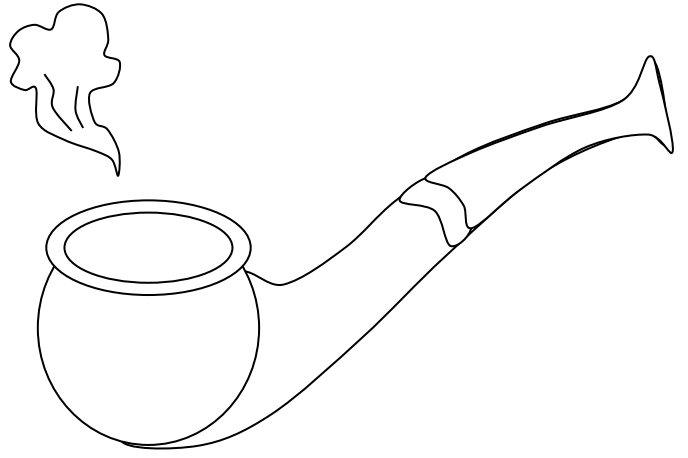

Write it.

i

ipe

ipe

NAME: \_\_\_\_\_

DATE: \_\_\_\_\_

Read it.

Draw it.

pipe

Write it.

i

ipe

ipe

NAME: \_\_\_\_\_

DATE: \_\_\_\_\_

Read it.

wipe

Color it.

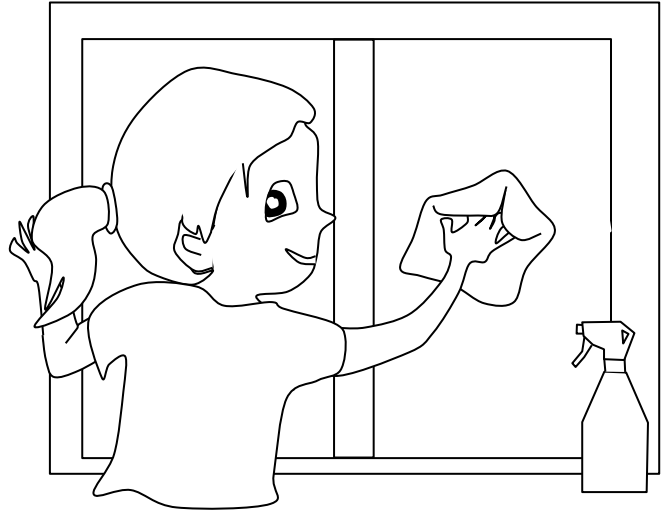

Write it.

i

ipe

wipe

NAME: \_\_\_\_\_

DATE: \_\_\_\_\_

Read it.

Draw it.

wipe

Write it.

i

ipe

wipe



NAME: \_\_\_\_\_

DATE: \_\_\_\_\_

Read it.

bite

Color it.



Write it.

i

ite

bite

NAME: \_\_\_\_\_

DATE: \_\_\_\_\_

Read it.

Draw it.

bite

Write it.

i

ite

bite

NAME: \_\_\_\_\_

DATE: \_\_\_\_\_

Read it.

kite

Color it.

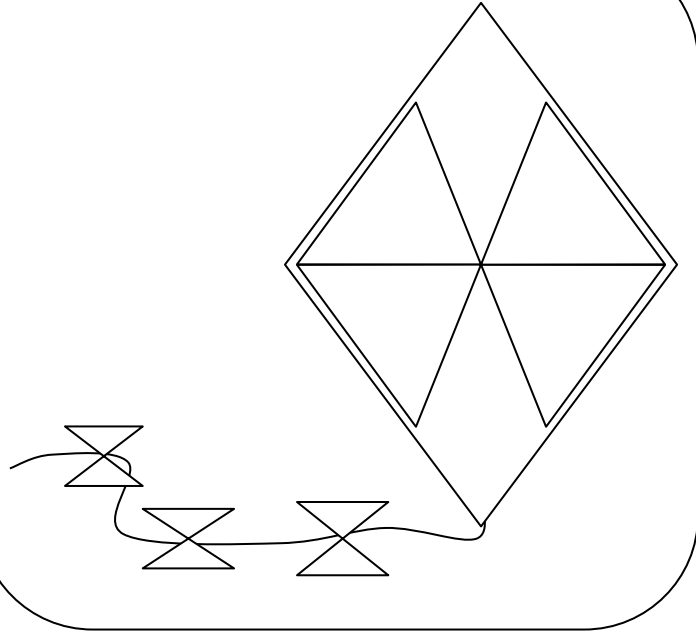

Write it.

i

ite

kite

NAME: \_\_\_\_\_

DATE: \_\_\_\_\_

Read it.

kite

Draw it.

Write it.

i

ite

kite

NAME: \_\_\_\_\_

DATE: \_\_\_\_\_

Read it.

dive

Color it.



Write it.

i

ive

dive

NAME: \_\_\_\_\_

DATE: \_\_\_\_\_

Read it.

dive

Draw it.

Write it.

i

ive

dive

NAME: \_\_\_\_\_

DATE: \_\_\_\_\_

Read it.

five

Color it.

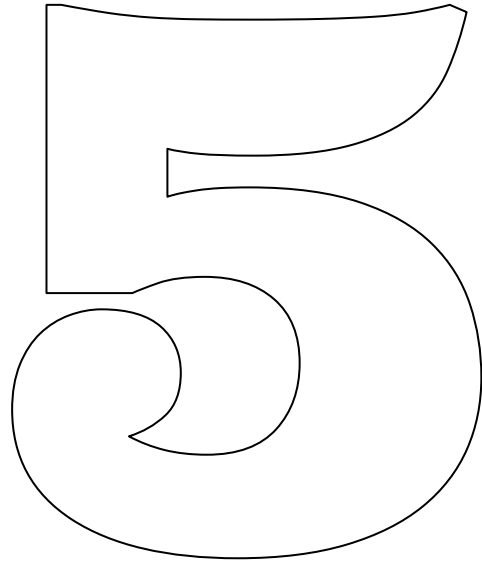

Write it.

i

ive

five

Blank handwriting practice lines consisting of a solid top line, a dashed middle line, and a solid bottom line.

NAME: \_\_\_\_\_

DATE: \_\_\_\_\_

Read it.

five

Draw it.

Write it.

i

ive

five



NAME: \_\_\_\_\_

DATE: \_\_\_\_\_

Read it.

**hose**

Color it.

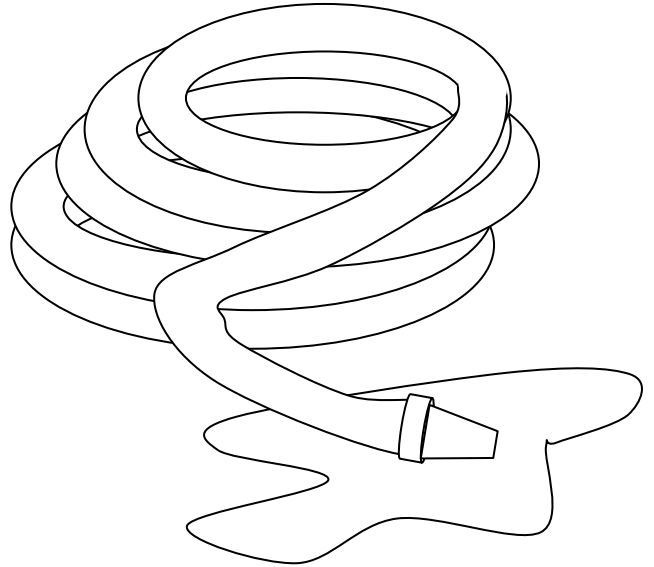

Write it.

o

ose

hose

Blank handwriting practice lines consisting of a solid top line, a dashed middle line, and a solid bottom line.

NAME: \_\_\_\_\_

DATE: \_\_\_\_\_

Read it.

Draw it.

**hose**

Write it.

o

ose

hose

NAME: \_\_\_\_\_

DATE: \_\_\_\_\_

Read it.

nose

Color it.

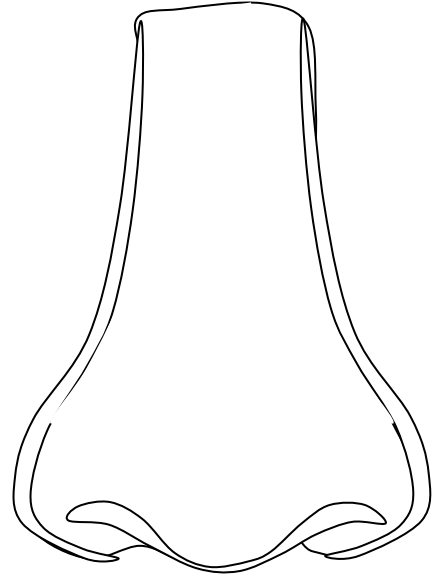

Write it.

o

ose

nose

NAME: \_\_\_\_\_

DATE: \_\_\_\_\_

Read it.

Draw it.

nose

Write it.

o

ose

nose

NAME: \_\_\_\_\_

DATE: \_\_\_\_\_

Read it.

pose

Color it.

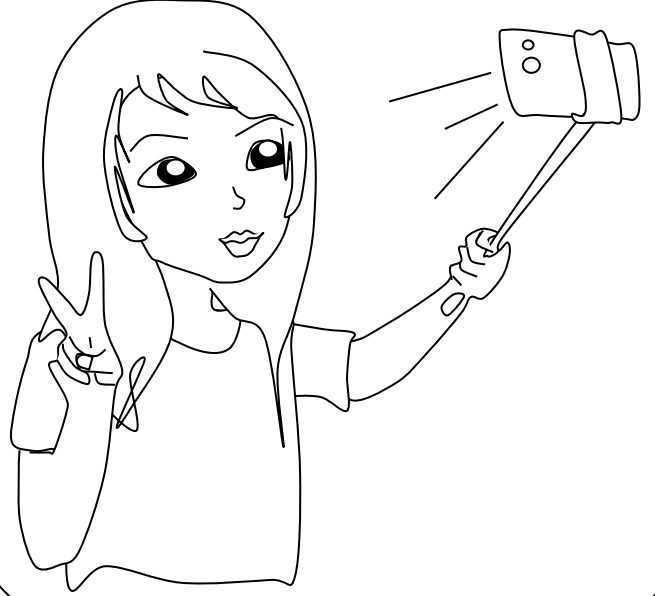

Write it.

o

ose

pose

NAME: \_\_\_\_\_

DATE: \_\_\_\_\_

Read it.

Draw it.

pose

Write it.

o

ose

pose

NAME: \_\_\_\_\_

DATE: \_\_\_\_\_

Read it.

rose

Color it.

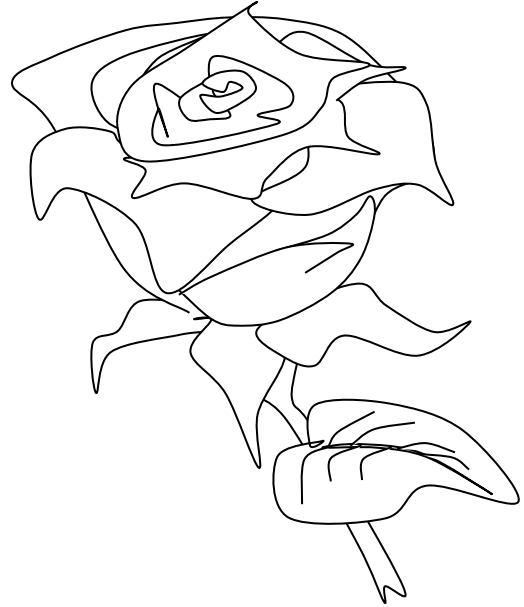

Write it.

o

ose

rose

NAME: \_\_\_\_\_

DATE: \_\_\_\_\_

Read it.

Draw it.

rose

Write it.

o

ose

rose



NAME: \_\_\_\_\_

DATE: \_\_\_\_\_

Read it.

Draw it.

hope

Write it.

o

ope

hope

NAME: \_\_\_\_\_

DATE: \_\_\_\_\_

Read it.

rope

Color it.

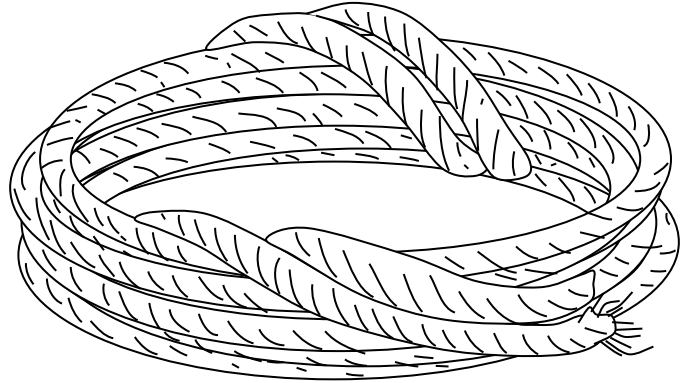

Write it.

o

ope

rope

NAME: \_\_\_\_\_

DATE: \_\_\_\_\_

Read it.

Draw it.

rope

Write it.

o

ope

rope

NAME: \_\_\_\_\_

DATE: \_\_\_\_\_

Read it.

note

Color it.

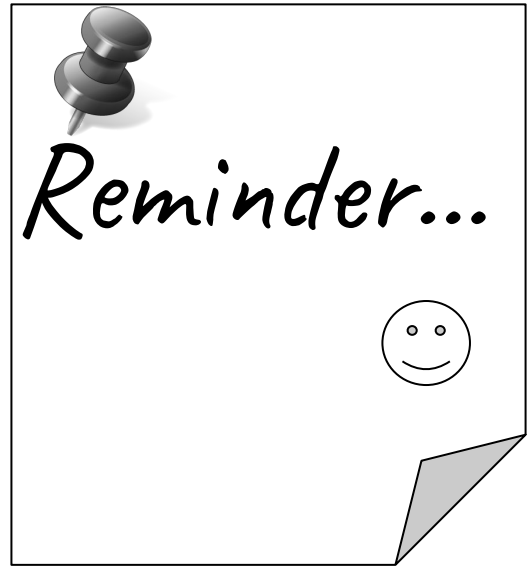

Write it.

o

ote

note

NAME: \_\_\_\_\_

DATE: \_\_\_\_\_

Read it.

hope

Color it.



Write it.

o

ope

hope

NAME: \_\_\_\_\_

DATE: \_\_\_\_\_

Read it.

Draw it.

note

Write it.

o

ote

note

NAME: \_\_\_\_\_

DATE: \_\_\_\_\_

Read it.

vote

Color it.

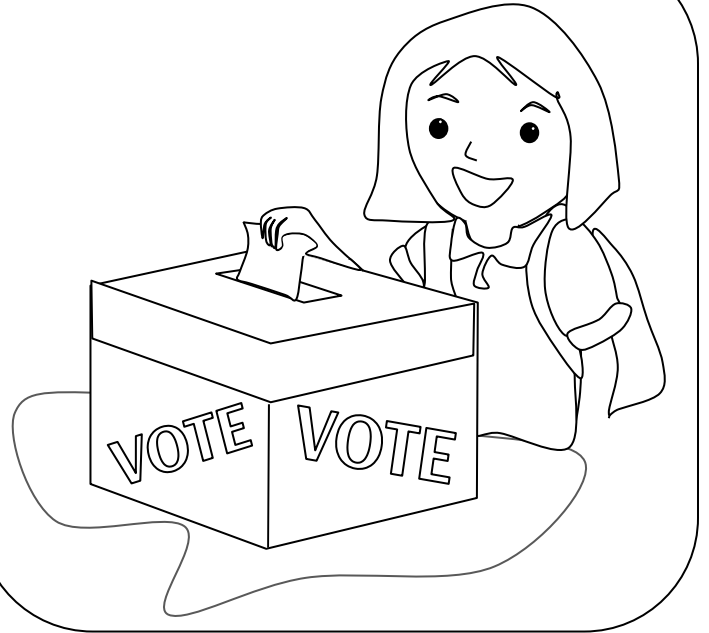

Write it.

o

ote

vote

Blank handwriting practice lines consisting of a solid top line, a dashed middle line, and a solid bottom line.

NAME: \_\_\_\_\_

DATE: \_\_\_\_\_

Read it.

vote

Draw it.

Write it.

o

ote

vote



NAME: \_\_\_\_\_

DATE: \_\_\_\_\_

Read it.

mole

Color it.



Write it.

o

o | e

m | o | e

NAME: \_\_\_\_\_

DATE: \_\_\_\_\_

Read it.

mole

Draw it.

Write it.

o

ole

mole

NAME: \_\_\_\_\_

DATE: \_\_\_\_\_

Read it.

hole

Color it.

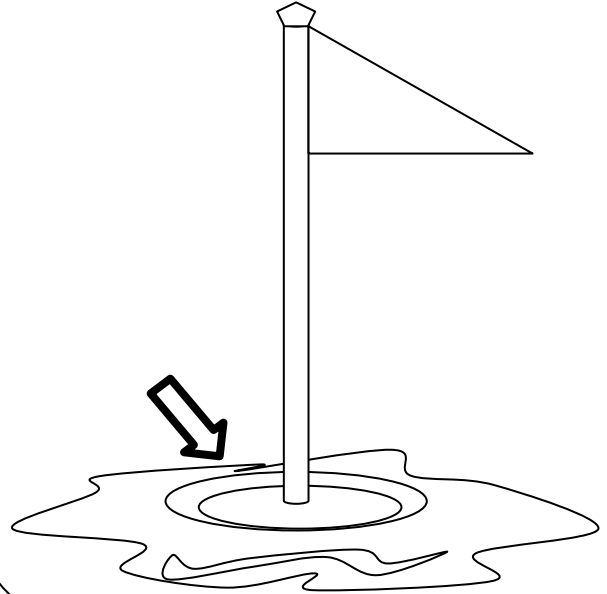

Write it.

o

o | e

h | o | e

NAME: \_\_\_\_\_

DATE: \_\_\_\_\_

Read it.

hole

Draw it.

Write it.

o

o | e

h | o | e

NAME: \_\_\_\_\_

DATE: \_\_\_\_\_

Read it.

pole

Color it.

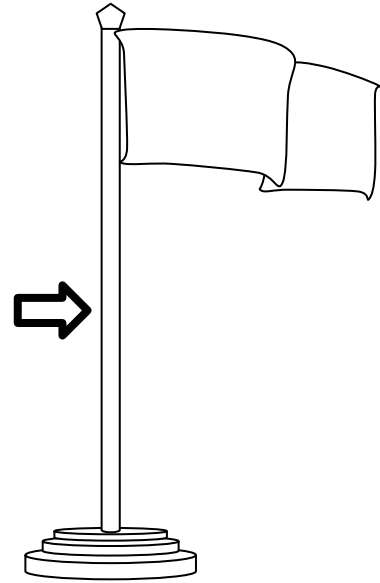

Write it.

o

o | e

p | o | l | e

NAME: \_\_\_\_\_

DATE: \_\_\_\_\_

Read it.

pole

Draw it.

Write it.

o

o | e

p | o | e

NAME: \_\_\_\_\_

DATE: \_\_\_\_\_

Read it.

sole

Color it.



Write it.

o

o | e

s | o | e

Blank handwriting practice lines consisting of a solid top line, a dashed middle line, and a solid bottom line.

NAME: \_\_\_\_\_

DATE: \_\_\_\_\_

Read it.

sole

Draw it.

Write it.

o

o | e

s | o | e



NAME: \_\_\_\_\_

DATE: \_\_\_\_\_

Read it.

dome

Color it.

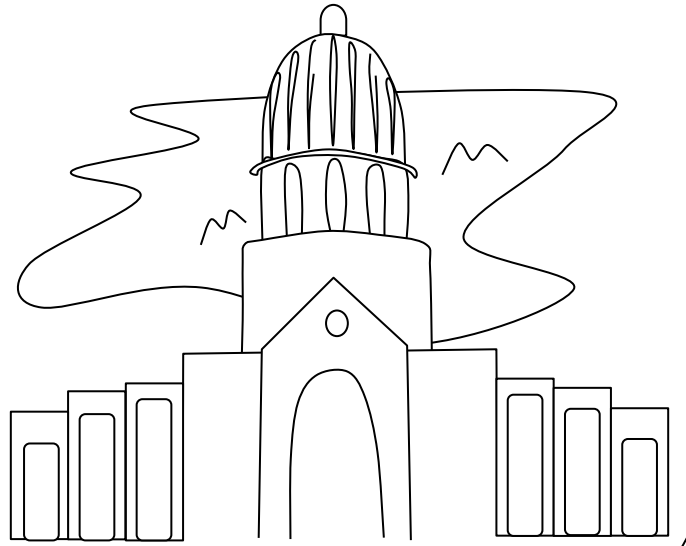

Write it.

o

ome

dome

NAME: \_\_\_\_\_

DATE: \_\_\_\_\_

Read it.

Draw it.

dome

Write it.

o

ome

dome

NAME: \_\_\_\_\_

DATE: \_\_\_\_\_

Read it.

home

Color it.

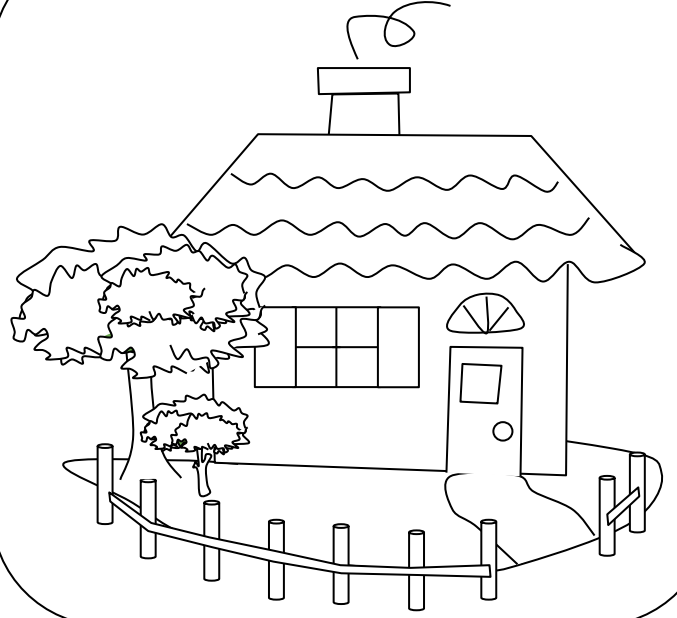

Write it.

o

ome

home

NAME: \_\_\_\_\_

DATE: \_\_\_\_\_

Read it.

Draw it.

home

Write it.

o

ome

home

NAME: \_\_\_\_\_

DATE: \_\_\_\_\_

Read it.

bone

Color it.

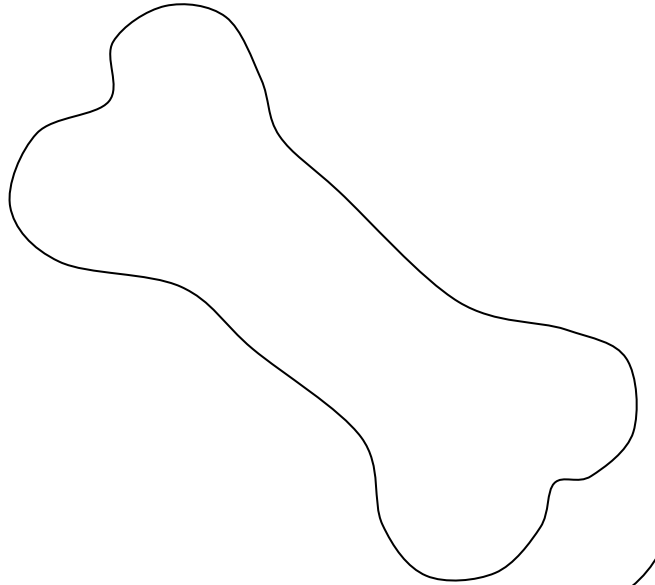

Write it.

o

one

bone

Blank handwriting practice lines consisting of a solid top line, a dashed middle line, and a solid bottom line.

NAME: \_\_\_\_\_

DATE: \_\_\_\_\_

Read it.

Draw it.

bone

Write it.

o

one

bone

NAME: \_\_\_\_\_

DATE: \_\_\_\_\_

Read it.

cone

Color it.

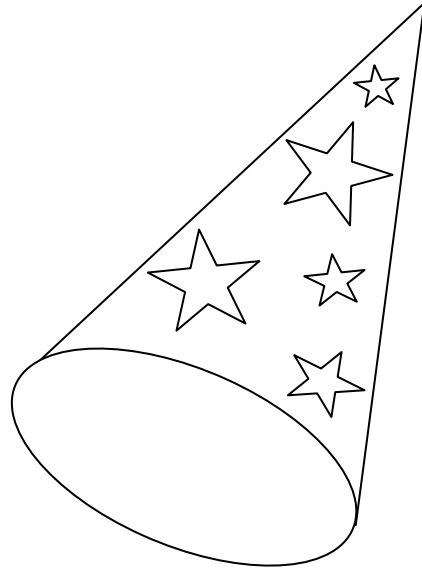

Write it.

o

one

cone

NAME: \_\_\_\_\_

DATE: \_\_\_\_\_

Read it.

Draw it.

cone

Write it.

o

one

cone



NAME: \_\_\_\_\_

DATE: \_\_\_\_\_

Read it.

cube

Color it.

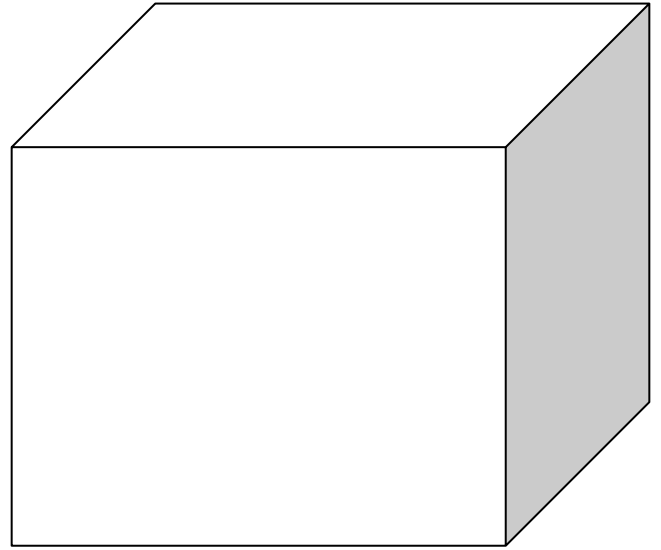

Write it.

u

ube

cube

Blank handwriting practice lines consisting of a solid top line, a dashed middle line, and a solid bottom line.

NAME: \_\_\_\_\_

DATE: \_\_\_\_\_

Read it.

cube

Draw it.

Write it.

u

ube

cube

NAME: \_\_\_\_\_

DATE: \_\_\_\_\_

Read it.

tube

Color it.

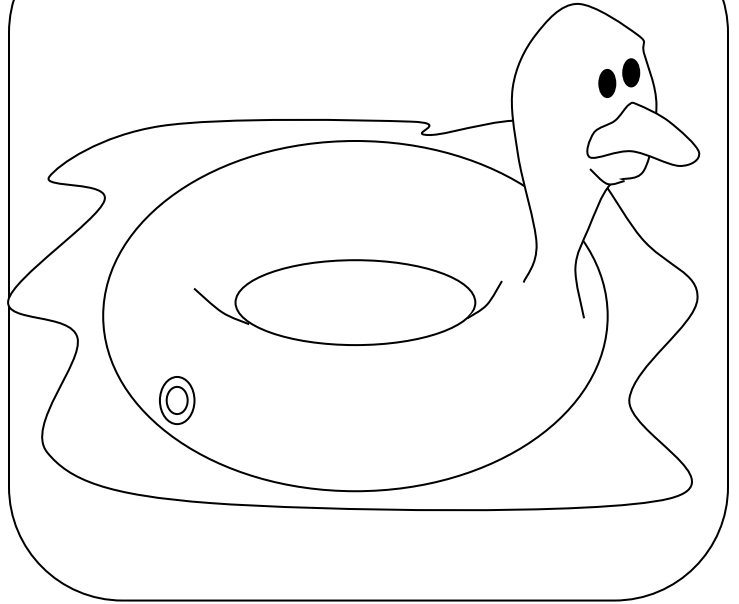

Write it.

u

ube

tube

NAME: \_\_\_\_\_

DATE: \_\_\_\_\_

Read it.

Draw it.

tube

Write it.

u

ube

tube

NAME: \_\_\_\_\_

DATE: \_\_\_\_\_

Read it.

mute

Color it.

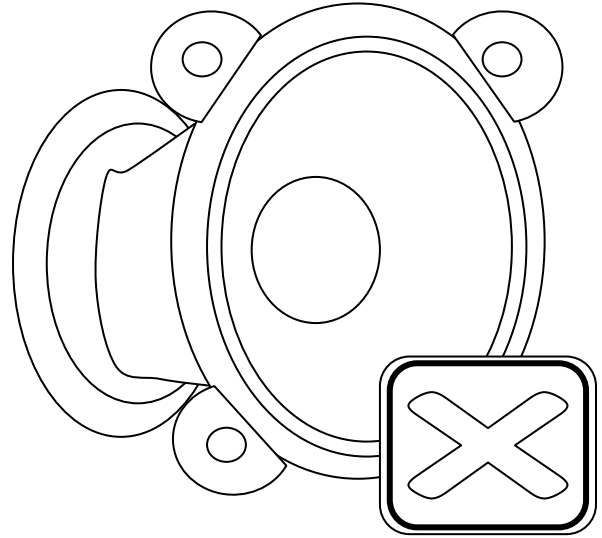

Write it.

u

ute

mute

NAME: \_\_\_\_\_

DATE: \_\_\_\_\_

Read it.

mute

Draw it.

Write it.

u

ute

mute

NAME: \_\_\_\_\_

DATE: \_\_\_\_\_

Read it.

cute

Color it.



Write it.

u

ute

cute

NAME: \_\_\_\_\_

DATE: \_\_\_\_\_

Read it.

cute

Draw it.

Write it.

u

ute

cute



NAME: \_\_\_\_\_

DATE: \_\_\_\_\_

Read it.

dune

Color it.



Write it.

u

une

dune

NAME: \_\_\_\_\_

DATE: \_\_\_\_\_

Read it.

Draw it.

dune

Write it.

u

une

dune

NAME: \_\_\_\_\_

DATE: \_\_\_\_\_

Read it.

tune

Color it.



Write it.

u

une

tune

NAME: \_\_\_\_\_

DATE: \_\_\_\_\_

Read it.

Draw it.

tune

Write it.

u

une

tune

NAME: \_\_\_\_\_

DATE: \_\_\_\_\_

Read it.

June

Color it.

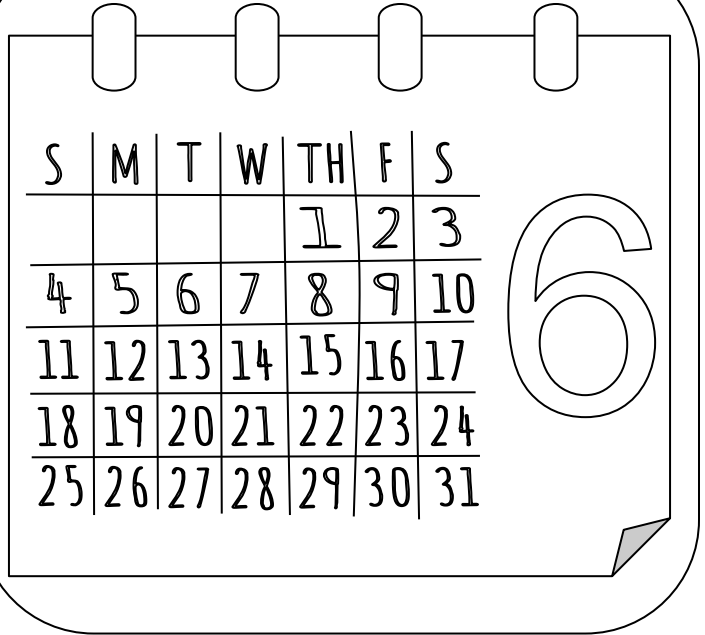

Write it.

u

une

June

NAME: \_\_\_\_\_

DATE: \_\_\_\_\_

Read it.

Draw it.

June

Write it.

u

une

June

NAME: \_\_\_\_\_

DATE: \_\_\_\_\_

Read it.

mule

Color it.

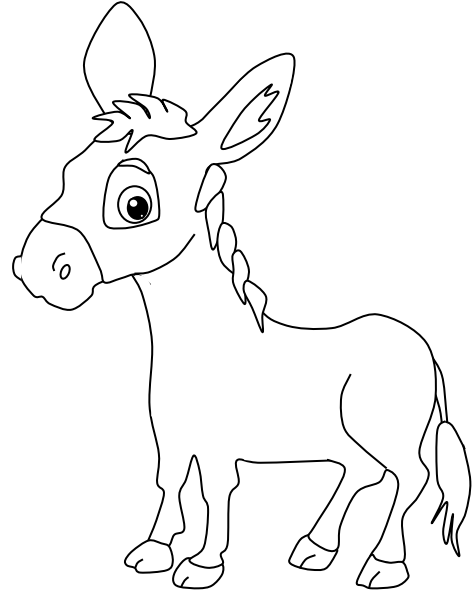

Write it.

u

ule

mule

NAME: \_\_\_\_\_

DATE: \_\_\_\_\_

Read it.

mule

Draw it.

Write it.

u

ule

mule



If you find any errors or you are unhappy for any reason, please let me know what I can do to fix it. You can email me at [ftsantomin30@gmail.com](mailto:ftsantomin30@gmail.com)

**Thank you!**

*Happy Teaching!!!*