

(a) Complete objects rotated along up-axis

Positive pairs

Negative pairs

Positive pairs

Negative pairs

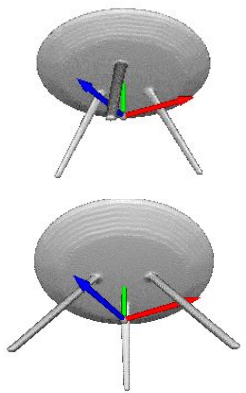

✓

✗

✓

✓

✓

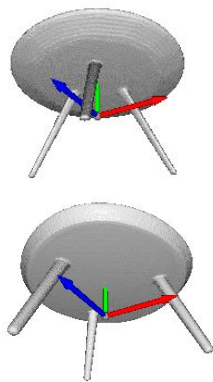

✗

✗

✗

✗

✗

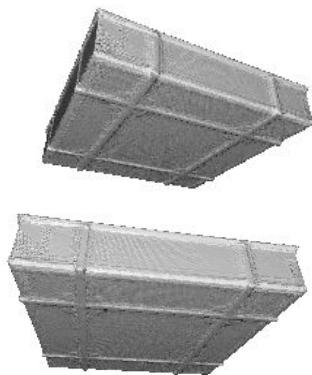

✓

✗

✗

✓

✗

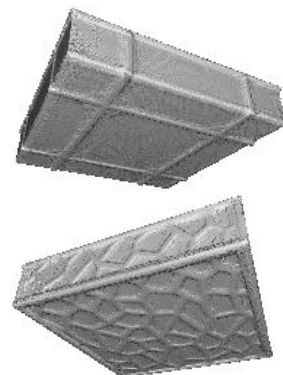

✗

✗

✗

✗

✗

(b) Complete objects rotated by SO(3)

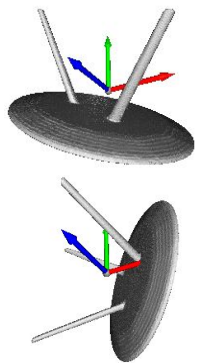

✓

✗

✓

✓

✓

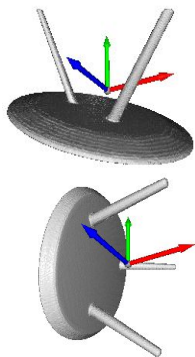

✗

✗

✗

✗

✗

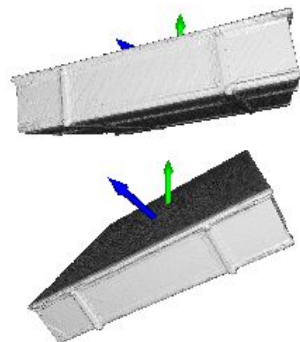

✓

✓

✓

✓

✓

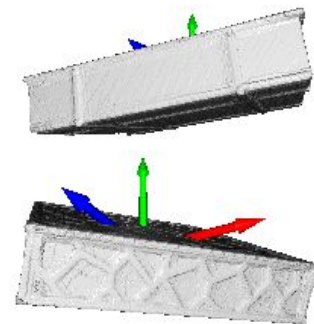

✗

✓

✗

✗

✗