



USB to Port



How do you transfer your image from the camera to the computer? (there are 3 ways).

Use the app

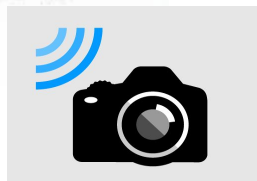

Canon



Card reader / external
Internal (back of Mac)



Computers off & submit
your diagram

Quiz #1

A.) What is the Class code for your period?

B.) What are the 3 components to the subject line when emailing work to Miss Wang? Example

C.) How many GB is your SD card?

D.) how many photos are in your photo album? List them.

E.) What is the URL for digital photography class website?

Name the parts



1.

2.

3.

4.



5.

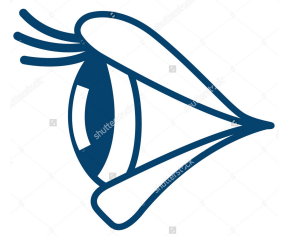

6.

7.



8. Name the red/white marking on the silver ring...
Explain how it is used to help in attaching the lens.



© KenRockwell.com

10. Put in sequence with the parts named from # 1-9

Just write the number in the order of operation (quick start guide)

Example: if you 5,3,2,1,etc

Extra credit:

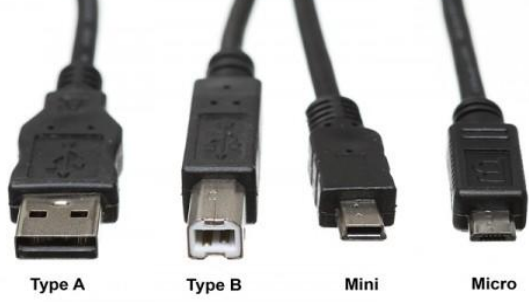

And / or what does DSLR stands for?



Camera Connect



Canon

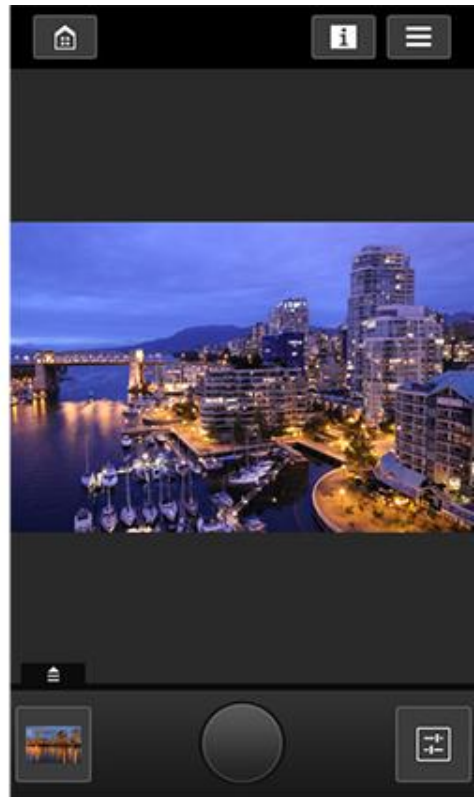
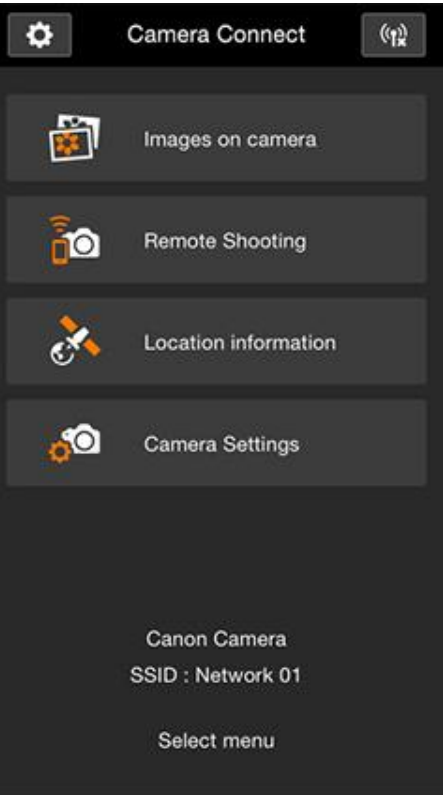

Word bank

Battery

Lens mount Index

LCD screen

Main Dial

Mode Dial

Playback button

Power switch

SD card

Shutter button

USB port

View Finder

Diagram labels

Battery

LCD monitor

Lens mount index

Main Dial

Mode Dial

Playback button

Power switch

SD card

Shutter button

USB port

View Finder

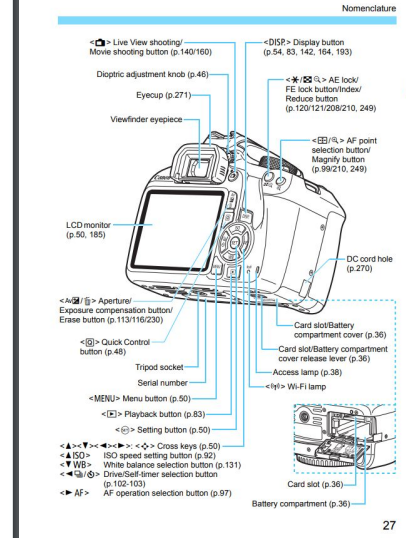
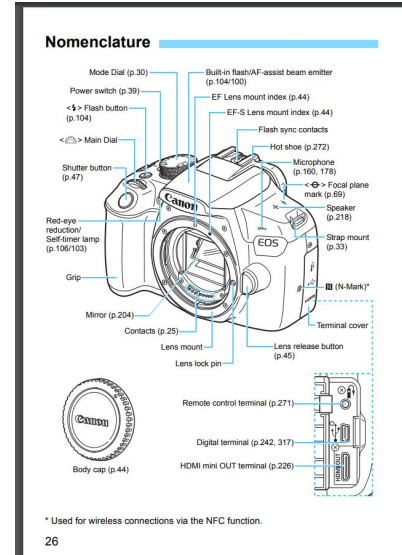

Submit DSLR diagram