

Gauge and Depth

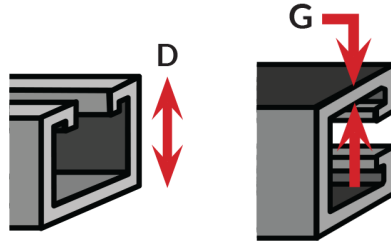

14 GAUGE 0.077
1-5/8" x 1-5/8" D

Length

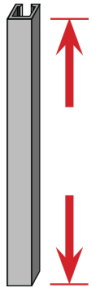





- **STANDARD 10'** (Shorter runs for easy handling)
- **STANDARD 20'** (Typical for longer runs)
- **6'8"** (Typical for commercial joists distance)
- **CUSTOM CUT-TO-LENGTH**



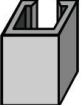



Perforation

	OVAL SLOT (Half slot) [9/16" x 1 1/8" x 2" on ctr.]
	LONG SLOT (Elongated slot) [13/32" x 3" x 4" on ctr.]
	ROUND HOLE [9/16" DIAM x 1-7/8" on ctr.]
	KNOCK OUT [7/8" DIAM x 6" on ctr.]
	CONTINUOUS CONCRETE INSERT
	SOLID (No perforation)

Material

	STEEL (Carbon steel, structural grade, 33,000 min yield)
	STAINLESS STEEL [304 or 316]
	ALUMINUM
	FIBERGLASS

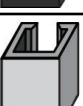
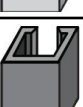
Finish

	PRE-GALVANIZED (Continuous galvanized) - G90 zinc coating weight for cost-effective long-term galvanic and barrier corrosion protection
	HOT DIPPED Galvanized (HDG – after fabrication, batch dip) where aqueous or exterior applications require greater corrosion protection
	GREEN Powder or “e”-coated painted topical coating
	PVC COAT Heavy PVC coat for extended barrier protection or cosmetic effects (May PVC coat over plain or galvanized)
	WIZCoat™ GALVANNEAL Paintable pregalvanized material requires no pre-treatment. Easily spray painted post-installation
	PLAIN Untreated, “plain” steel with no topical/barrier coating
	GOLD Yellow zinc dichromate electro-galvanized
	CUSTOM COLORS Custom powder coating available in virtually any color variations



Gregory G-STRUT Submittal Form

Project Name	
Project Start Date	
Architect or Engineer	
Phone	
Contractor(s)	
Address	
City	
State	
Zip	

Approval



G584 SERIES METAL FRAMING STRUT CHANNEL

1-5/8" x 1-5/8" (1.625" x 1.625") • 14 gauge (0.077" thick)

	G584OS [Oval-Slot] 9/16" x 1-1/8" - 2" ON CTR		G584A [Back-to-Back] WELDED
	G584LS [Long-Slot] 13/32" x 3" - 4" ON CTR		G584AOS [Back-to-Back Oval-Slot] WELDED
	G584H [Holes] 9/16" DIAM. - 1-7/8" ON CTR		G584KO [KNOCK OUT] 7/8" DIAM. - 6" ON CTR

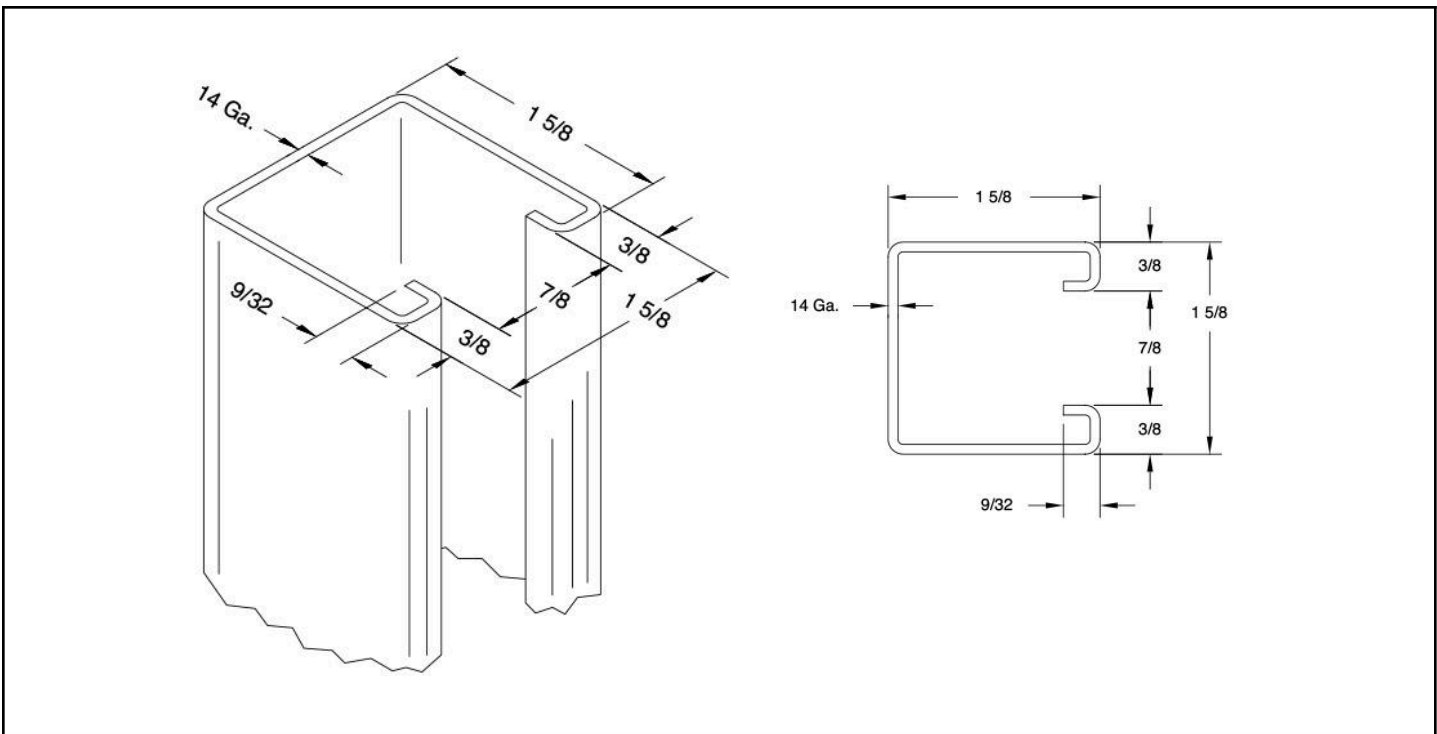

ITEM	QNT'Y	DESCRIPTION	MATERIAL
			ROLLFORM TOLERANCES
SCALE	FULL	CHK'D BY	LENGTH ± 0.125"
DWN BY	IDI	02-02-02	APP'D BY
ALL OTHER DIMENSIONS ± 0.020"			

G-STRUT CHANNEL, PART # G584

CAD FILENAME G584	GREGORY STRUT PRODUCTS Division of Gregory Industries 4100 13th Street SW, Canton, OH 44710 PH: 330-477-4800 • FX: 330-477-0626	REF. No.
LAST PLOT DATE 02-02-02		DRWG No. G584

This drawing is the property of Gregory Strut Prod. and is loaned without other consideration than the agreement and condition that it is not to be reproduced, copied or otherwise disposed of, directly or indirectly, and is not to be used in whole or in part to assist in making or to furnish any information for the making of drawings, prints apparatus or parts thereof. This drawing shall be returned to Gregory Strut Prod. upon request. The acceptance of this drawing will be construed as an acceptance of the foregoing conditions, and as an admission of the exclusive ownership in and to the drawing of Gregory Strut products.



G584 SERIES METAL FRAMING STRUT CHANNEL

ELEMENTS OF SECTION								
			X-X AXIS			Y-Y AXIS		
Strut Section No.	Weight/ Foot lbs.	Area of Section in. ²	Moment of Inertia in. ⁴	Section Modulus in. ³	Radius of Gyration in.	Moment of Inertia in. ⁴	Section Modulus in. ³	Radius of Gyration in.
G584	1.429	0.42	0.146	0.16	0.59	0.184	0.226	0.662
G584A	2.858	0.84	0.721	0.444	0.926	0.368	0.453	0.662

BEAM & COLUMN LOADS					
Strut Section Number	Beam Span or Column Height	Maximum Column Load	Total Uniform Load @25,000 psi	Deflection @ 25,000 psi	Uniform Load @ 1/240 Span Deflection
	in.	lbs.	lbs.	in.	lbs.
G584	12	8630	2660	0.01	-
	18	8370	1770	0.03	-
	24	8090	1330	0.05	-
	30	7760	1060	0.08	-
	36	7410	880	0.12	-
	42	7030	760	0.17	-
	48	6620	660	0.22	580
	54	6190	590	0.28	460
	60	5720	530	0.35	370
	66	5230	480	0.42	310
	72	4710	440	0.5	260
	84	3590	380	0.69	190
	96	2750	330	0.89	140
	108	2170	290	1.12	110
	120	1760	260	1.38	90
	132	1450	240	1.69	70
	144	-	220	2.02	60
	156	-	200	2.33	50
	168	-	190	2.77	40
	180	-	170	3.04	40
	192	-	160	3.48	30
	204	-	150	3.91	30
	216	-	140	4.33	20
	228	-	140	5.1	20
	240	-	130	5.52	20



G584 SERIES METAL FRAMING STRUT CHANNEL

BEAM & COLUMN LOADS					
Strut Section Number	Beam Span or Column Height	Maximum Column Load	Total Uniform Load @25,000 psi	Deflection @ 25,000 psi	Uniform Load @ 1/240 Span Deflection
	in.	lbs.	lbs.	in.	lbs.
G584A	12	17650	7400	0	-
	18	17420	4930	0.01	-
	24	17160	3700	0.03	-
	30	16890	2960	0.04	-
	36	16590	2460	0.07	-
	42	16270	2110	0.09	-
	48	15930	1850	0.12	-
	54	15570	1640	0.16	-
	60	15200	1480	0.19	-
	66	14520	1340	0.23	-
	72	13580	1230	0.28	-
	84	11550	1050	0.38	940
	96	9320	920	0.5	720
	108	7360	820	0.64	570
	120	5960	740	0.79	460
	132	4920	670	0.95	380
	144	4140	610	1.13	320
	156	3520	560	1.32	270
	168	-	520	1.53	230
	180	-	490	1.77	200
	192	-	460	2.02	180
	204	-	430	2.27	160
	216	-	410	2.57	140
	228	-	380	2.8	120
	240	-	370	3.18	110

For Perforated Channels, Reduce Total Beam Load Values as Follows:

G584/G584A	OS	21%
G584/G584A	LS	34%
G584/G584A	H	13%
G584/G584A	KO	5%

E = 29000; Fy = 42700; K = 0.8



G584 SERIES METAL FRAMING STRUT CHANNEL

COLUMN LOADS: Column loads are for allowable axial loads for the unsupported heights listed (including a K value of 0.80). Column loads must be reduced for eccentric loading.

BEAM LOADS: Loads listed are distributed uniformly. For loads concentrated at center of span, multiply uniform load by 0.5 and deflection by 0.8. Where deflection is not a factor, use stress of 25,000 PSI. When deflection is a factor, use deflection of 1/240 span.