

# SOY LA VOCAL "E"

- **Decora la vocal "E"**

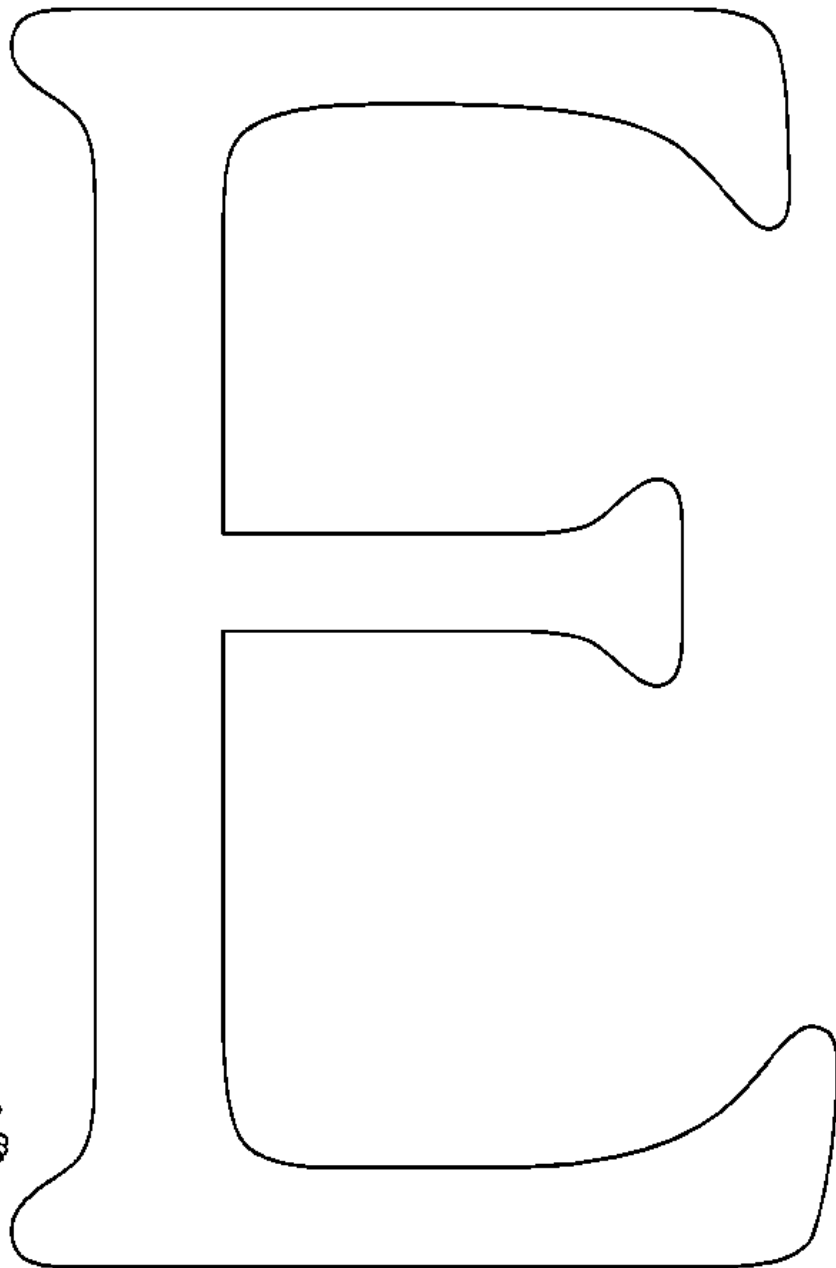

- ***Pinta las figuras cuyo nombre empiece con la vocal E.***

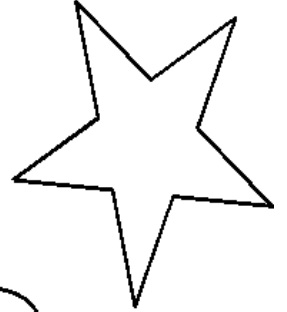
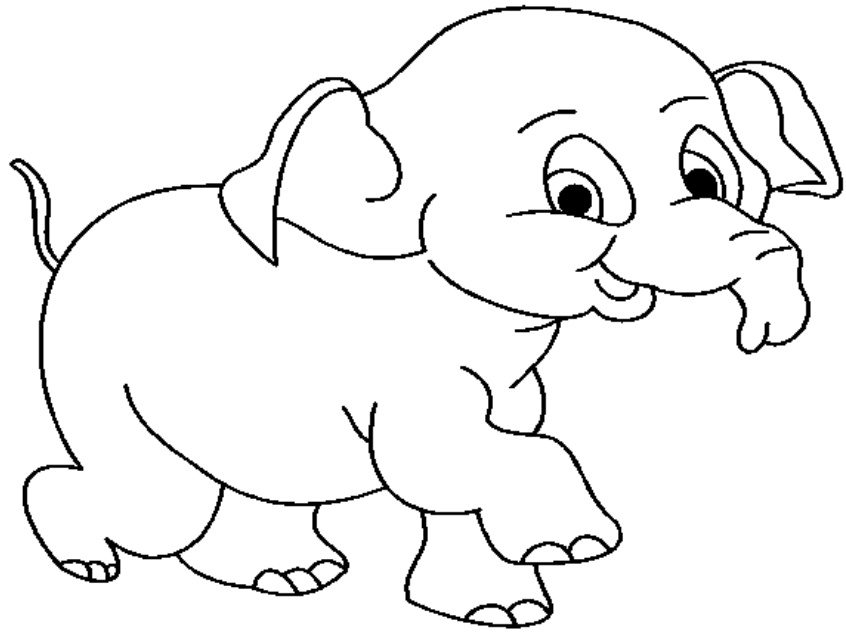

**E**



**Anteojos**



**Enano**

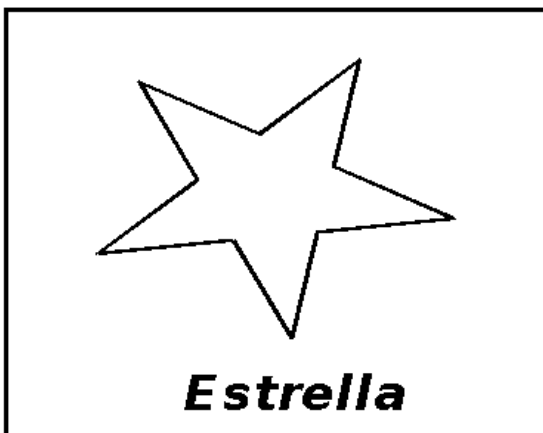

**Estrella**

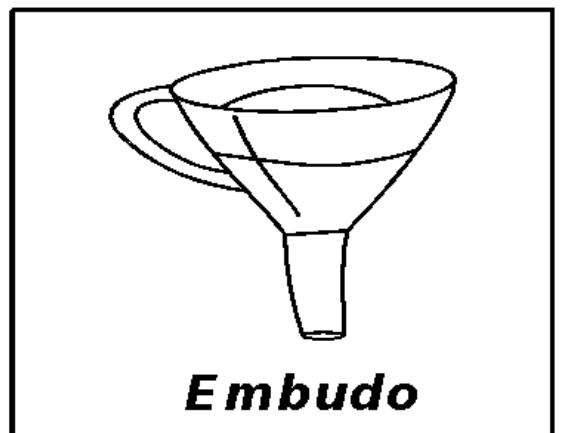

**Embudo**

*LA VOCAL "E"*

□ *Delinea la vocal E con plumón grueso.*

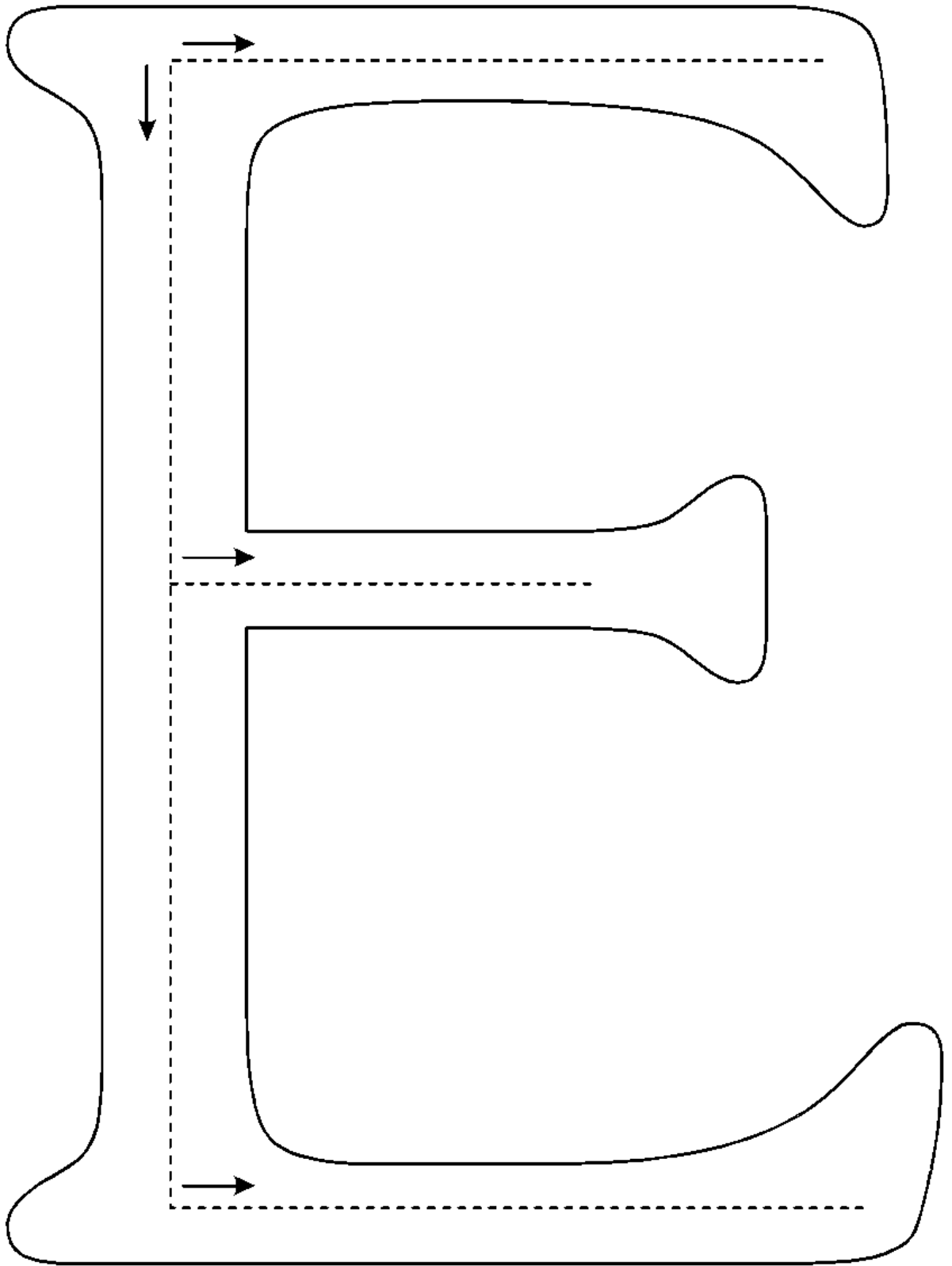

*Traza con plumón.*

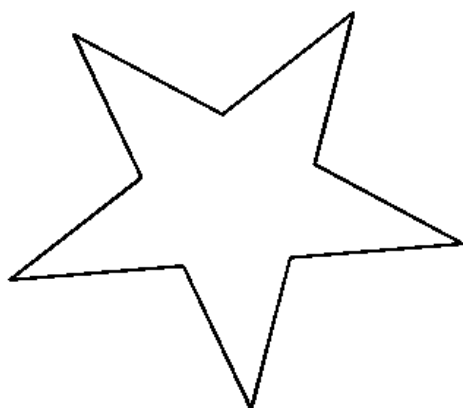

**ESTRELLA**

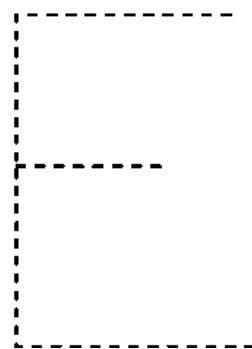
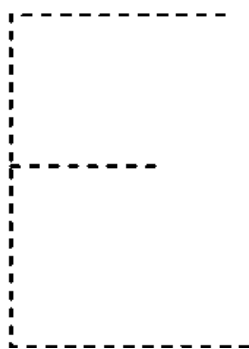
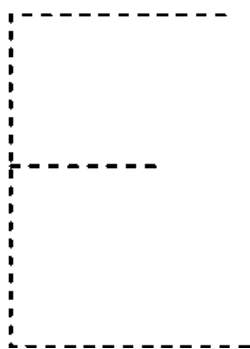
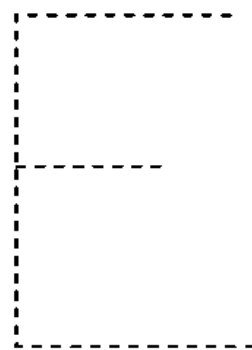
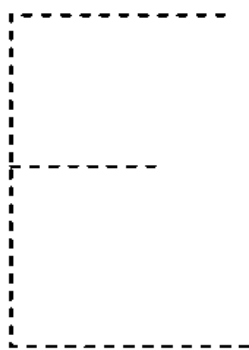
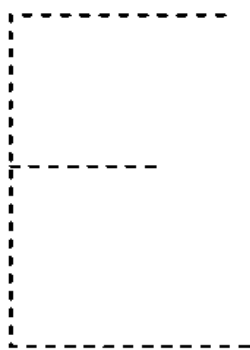
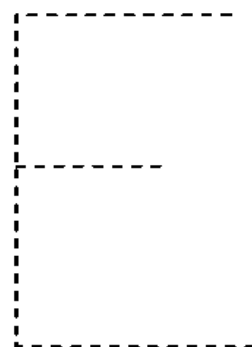
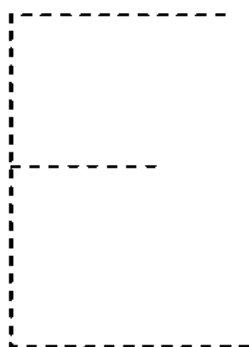
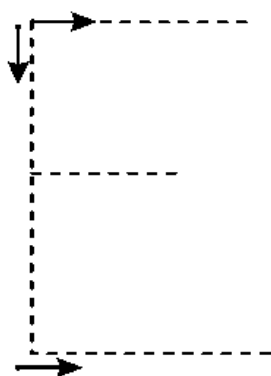

- ***Une las figuras con la vocal cuyo nombre empieza.***



**Árbol**

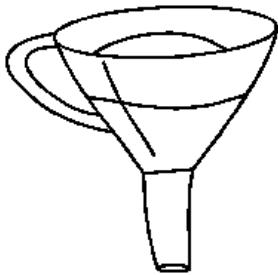

**Embudo**

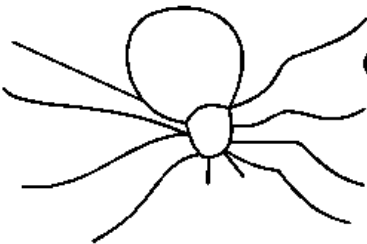

**Araña**



**Enano**



• **A**

**E**