

CUANTIFICADORES: MENOS – MÁS

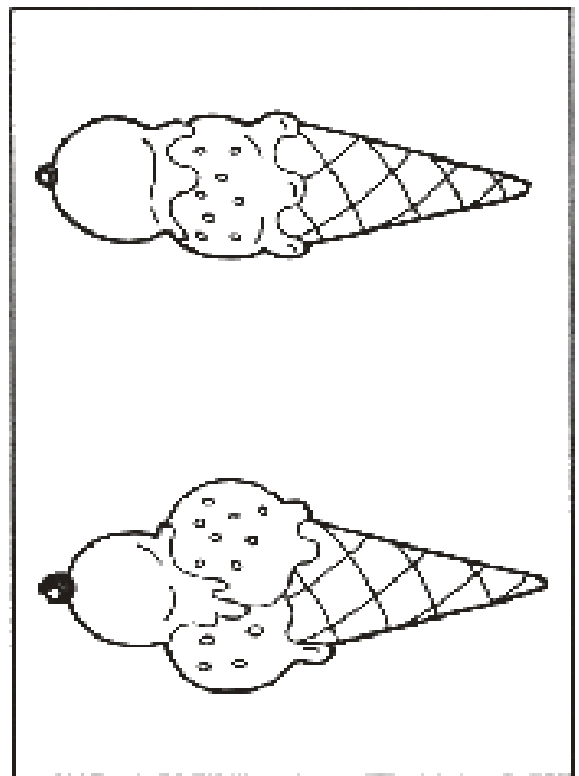

- ⊖ Marco con plumón rojo donde hay más.
- ⊖ Marco con plumón azul donde hay menos.

MÁS

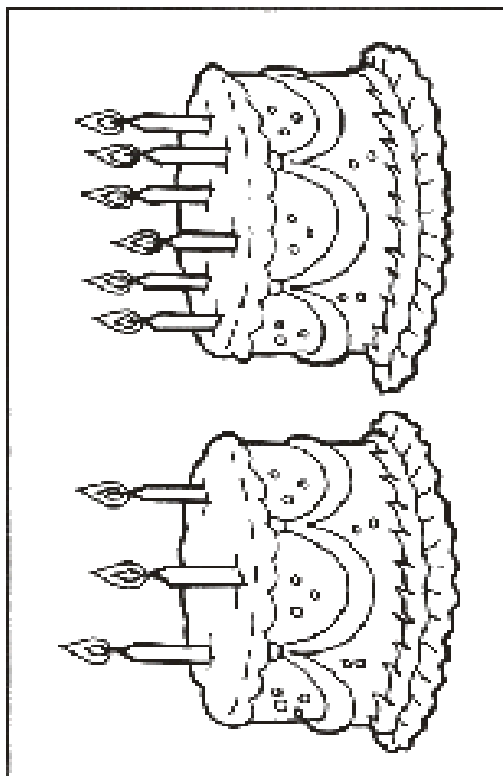
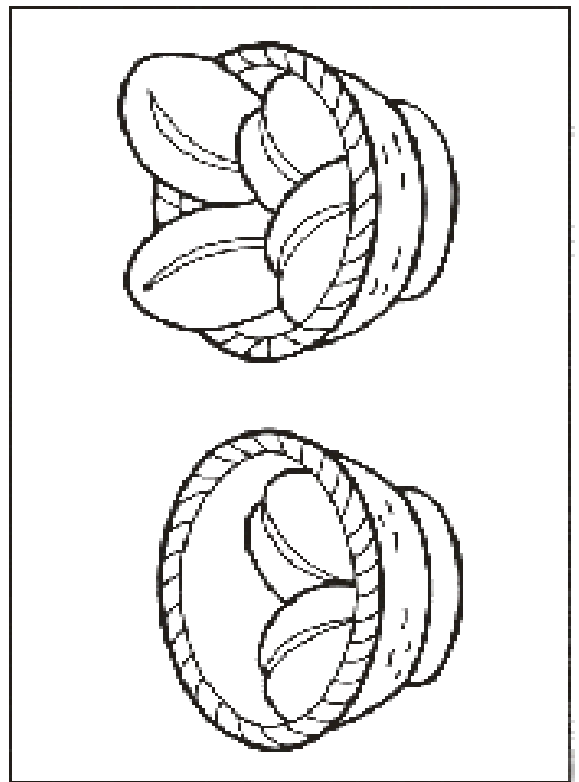
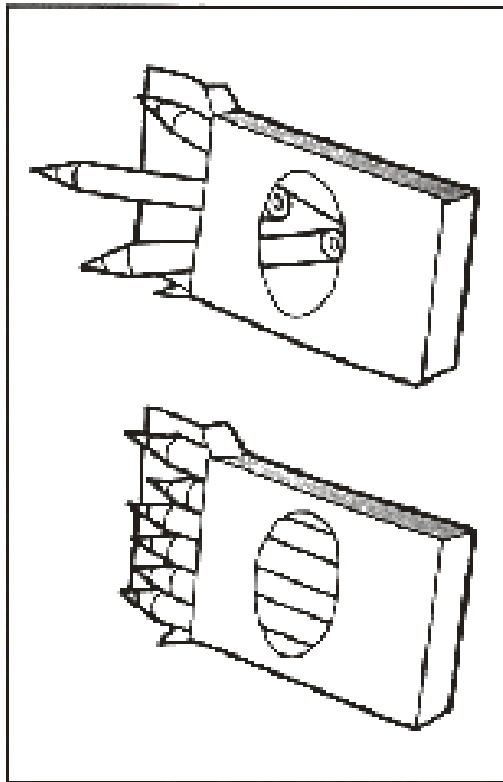

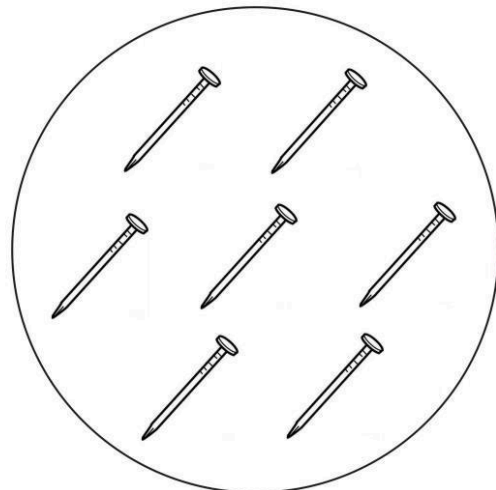
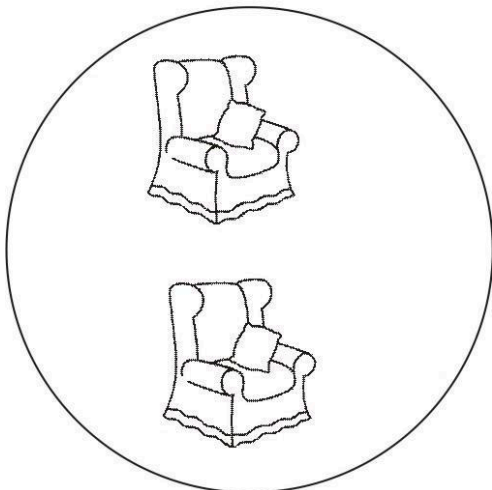
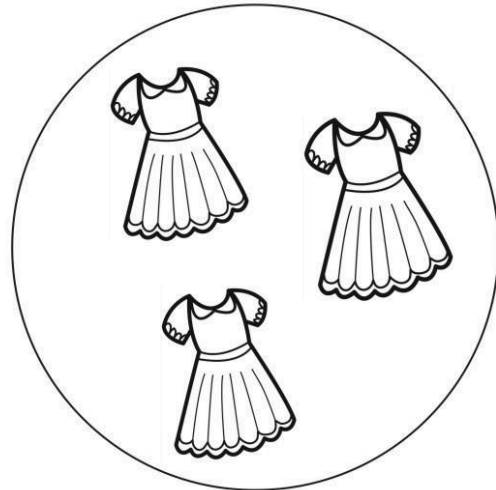
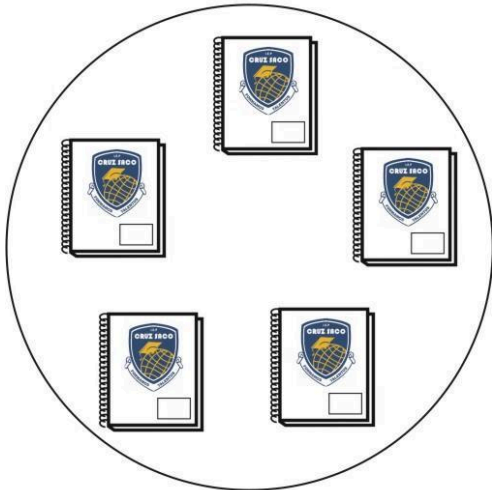
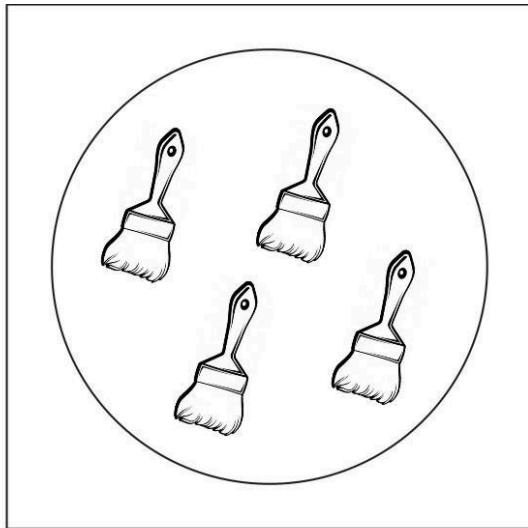

MENOS Marco con una cruz los conjuntos que tienen más elementos que el modelo.



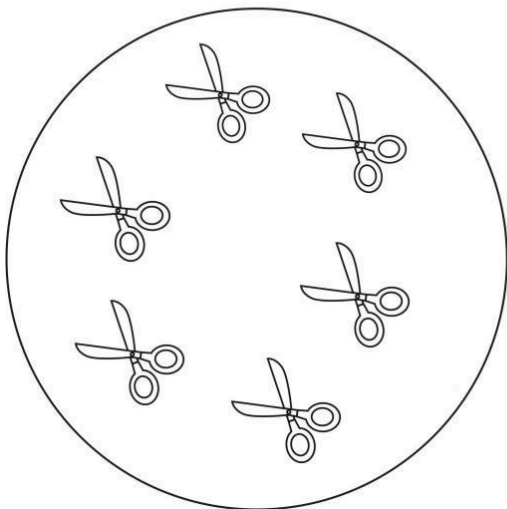
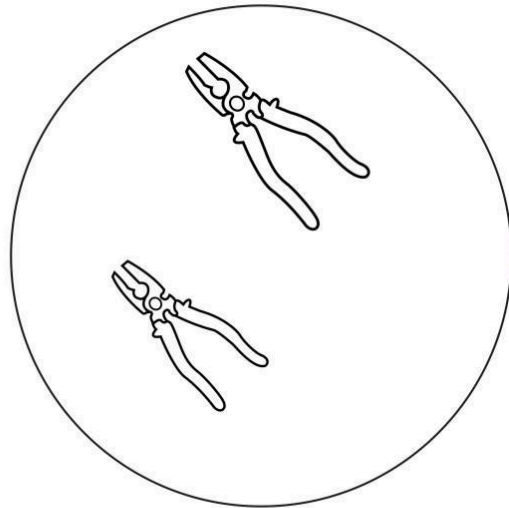
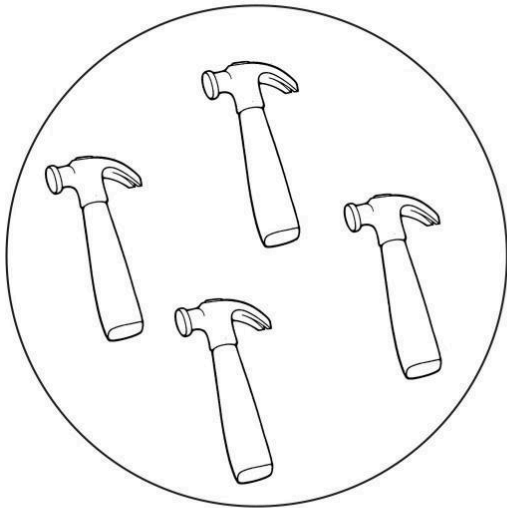
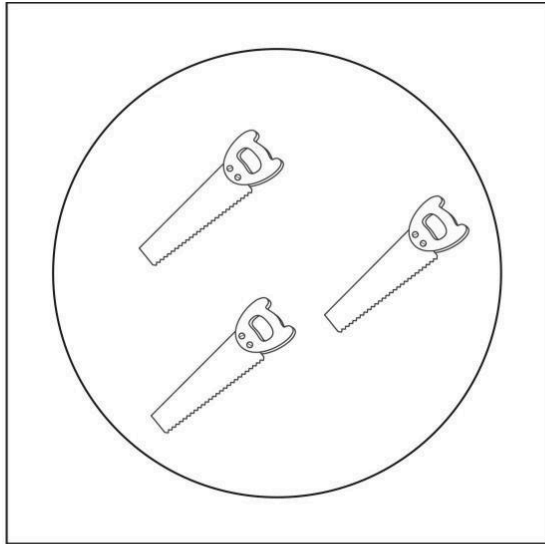

CUANTIFICADORES: MENOS - MÁS



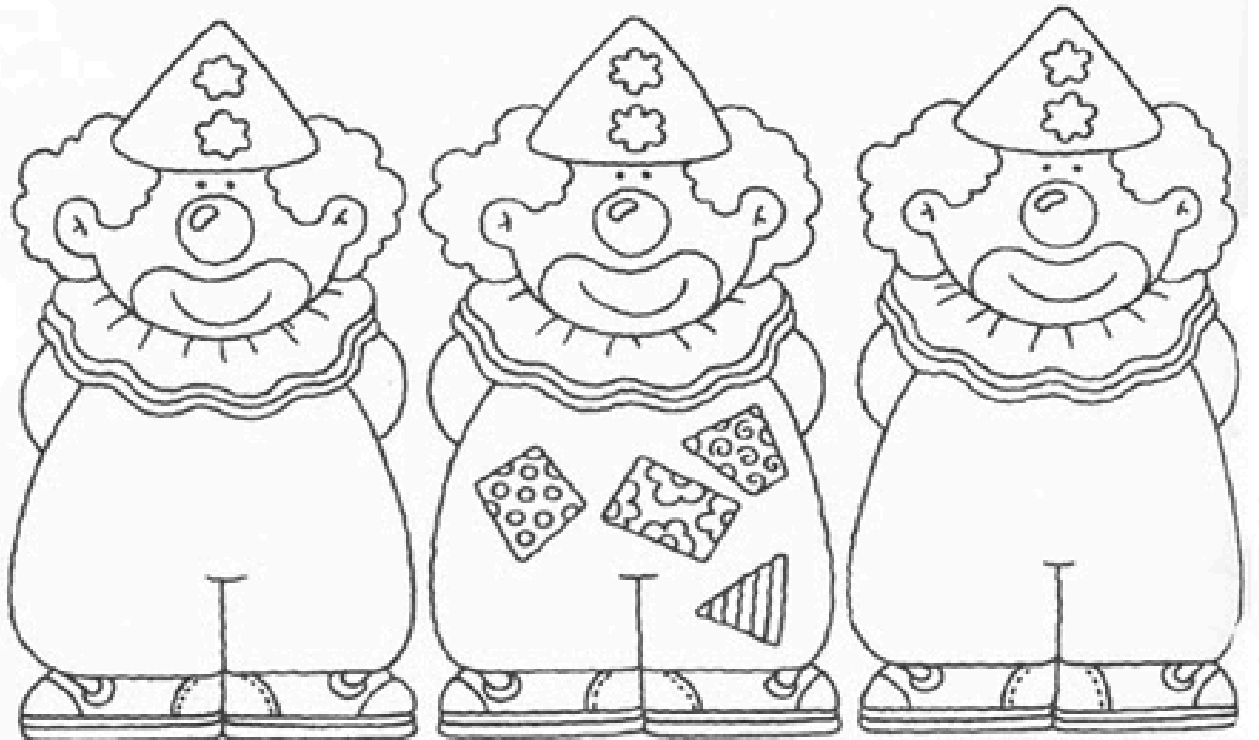
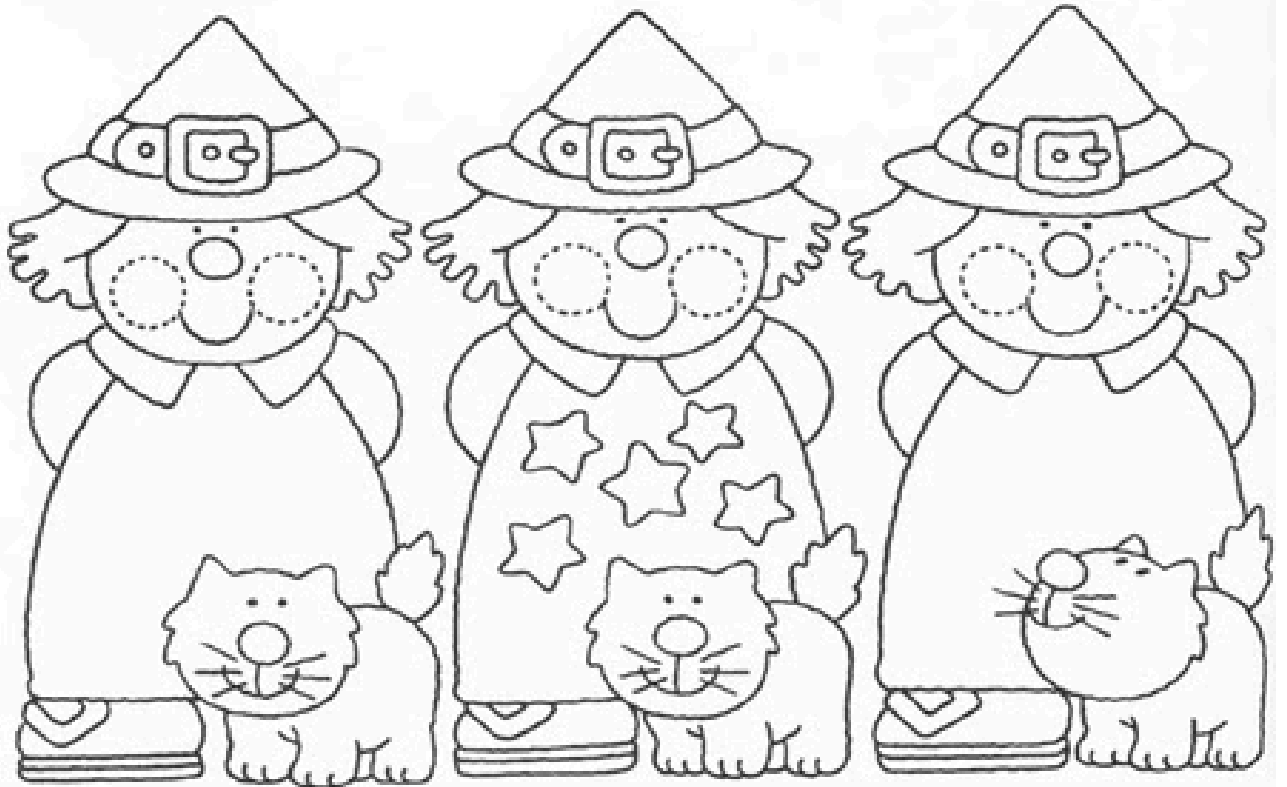

- ③ Decoro los trajes con estrellas y parches
- ③ Los de la derecha tienen menos que los del medio.
- ③ Los de la izquierda tienen más que los del medio.

