

PROTOTYPE LIST FOR BRICKARMS

Resources: Flickr accounts of Will Chapman+ Enigmabadger, [The Brickarms Spreadsheet](#), EvilFireDemon+Arduino+Elijah+Dr. O+Floodllama+Starwarsstudio100+Mr_BigBond+fallout_bricks+Banana Assassin+SamTheLegoMan+Viggs+Dashbricks+_mu110_+Thrawnbuilds on Discord.

Key:

BA=Brickarms

WW=Workshop Wonders

BKM=Brickmania

CB=Citizen Brick

This list isn't just for listing prototypes, but for also documenting old items, or BA items that are rare in some capacity.

RIFLES:

-Gorilla Carbine (Went with a set of minifigs from CB. Based on Planet of the Apes)



-WUNDERWAFFE DG-2BA V1 (In a BKM crate that dropped on Black Friday)



•V2 (Removable bulbs)

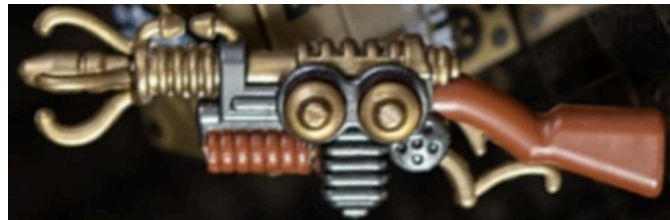

•V3



-Gewehr 98 Proto



-SVT-40 V1



-SKS Proto



-SKS OM



-Kar98k Proto (Doesn't have that little piece under the barrel, also slightly more tapered)



-Kar98k Reloaded Non-OM



-E-10



-E-10R



-DLT-20A



-A295 Proto



-A295 OM



-Centurion Raider Rifle Non-OM



-BAR-42 (A mod made by Will's son, Ian, that got turned into a mold)



-BAR Proto V1



•OM



-BAR Proto V2



-Perfect Caliber Barrow BAR (comes with the BKM Bonnie and Clyde Getaway Car)



-CA-87 OM



-XLR Wireframe (named "Blueprint")

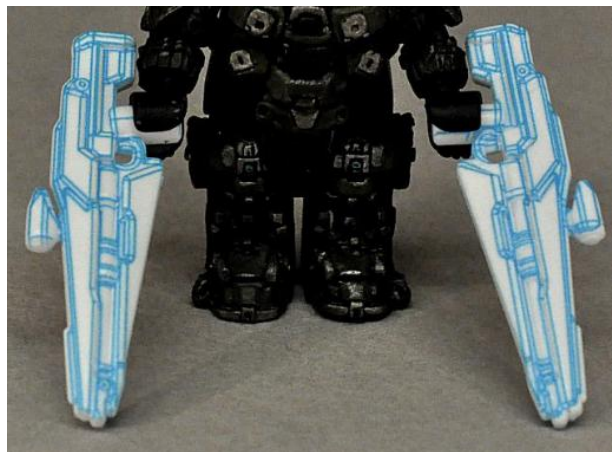

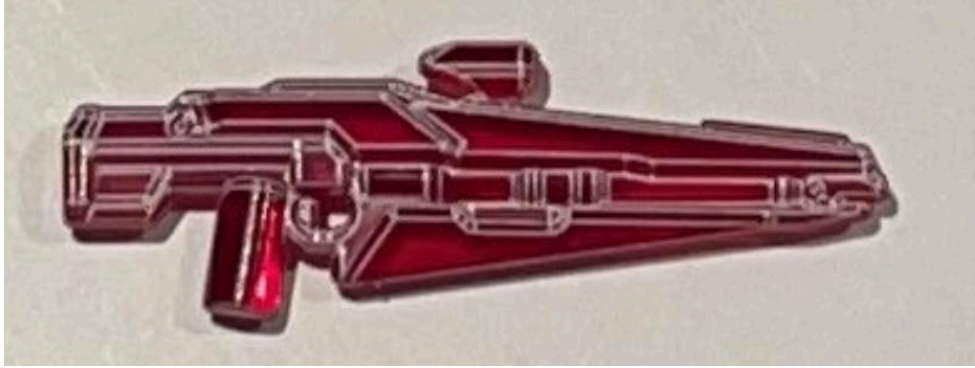

-XLR OM (Convention/Contributor Pack Item)



-Arisaka w/ Bayonet OM



•V1 OM



-Lee Enfield SMLE Mk3 OM (From the WWI Allies Battle Pack)



-Lee Enfield SMLE Mk3 w/ Bayonet OM



-EE-3 Stockless



-EE-3 BoB Stockless



-Flintlock Musket Proto (Mix of flintlock and caplock)



-Short-Barreled Flintlock Musket Proto



-Lever Action Rifle Proto (Smaller lever)



-M1 Garand Proto



-A280C

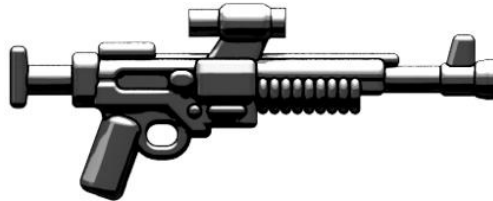

-DC-15 Proto (No block part in the receiver)



-EL-16HFE OM



PISTOLS / HANDGUNS:

-A280-CFE Blaster



-Colonial Blaster



-DH-17 V1



•OM



-Flame Gun



-Retro Raygun OM (Only a few made)



-Flintlock Pistol V1



-Left-Handed Flintlock Pistol



-LAPD 2049 Blaster (Goes with the OM M2019 Blaster from Bladerunner)



-A180 Blaster OM



-Marshal Pistol OM (VERY difficult to overmold)



-Dark Warrior Pistol OM



-M1917 Revolver Proto



•OM



-McCree's Revolver (From Overwatch)



•OM



-Pod Gun (From Fifth Element as a convention item)



•OM (Will cut a Pod Gun and placed it in the mold)



-TOS Phaser (From Star Trek; Went with the BKM Starship Bridge kit)



•Non-OM



-Radi8 RMR Proto (Different sight plus some detailing under the barrel, not on the production variant)



-Radi8 Scopeless (All Radi8's are from Fallout. This was a WW item)



-Radi8 Scope 1 (Used for a project from Eclipsegrafx and Will)



-Radi8 Scope 2 (WW item)



-SE-14R (Lando Calrissian) (Special variant of this light blaster)



-Needle Gun OM (Convention/Contributor Pack exclusive, first triple-overmold)



-Plasma Pistol OM (Convention/Contributor Pack exclusive)



-Golden Gun (When with the Spy Pack; from James Bond)



-Joint Force Standard Laser Gun (Couldn't be released due to legal issues)



•OM



-Derringer Proto



-M1851 Reloaded



•Non OM



-UCS MODCOM OM



-DL-44 Proto V1



•V2



-PO8 Luger Proto (Slimmer profile with a different shape for it's mag and barrel)



-Marshall Pistol V2 (WW item)



-M2019 Reloaded Non-OM (A version of the M2019 OM where the OM technique is not applied)



-E-11P w/ OM Fins (Too small; shortshots were common)



-E-11P Non-OM



•No fins



-M2008 Non-OM



-MW-20 V2 (Different grip)

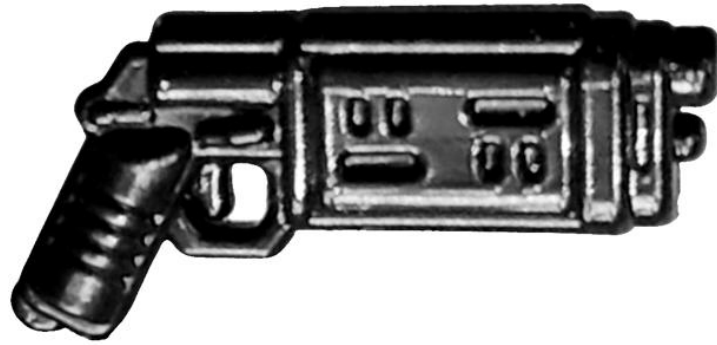

-Gunblade Proto



-HC-1 OM (Made by thejoker in Will's workshop)



-Galactic Gunfighter Pistol w/ No Trigger



SUBMACHINE GUNS:

-Briefcase Uzi (Will had to drill holes in the briefcase and cut Thompson mags for these)



-Briefcase TD9



-TD9 Proto (No heat shield)



•Other Proto (No ejection chamber)



-M11 Blade "Daywalker" OM



-FMG Proto



-MP18 Non-OM



-MP40 V2 (Not gripable from the top)



•Folded Stock



-MP7



-PPSH Proto V1 (Not made due to the mag bending the gun upward)



-PPSH Proto V2 (Thicker stock and trigger guard)



-PPSH Stick Mag Non-OM



-Sten Gun Proto (Mag clips snapped easily)



-XVR V1 OM



-XVR V2



-XVR V3



•OM



-Sterling



-Combat PDW OM (Will cut a black P90, then stuck it in the mold for a one-time OM)



-M1918 Machine Gun Proto (Different clip on the drum that was more prone to breaking)





-M1A1 Thompson without Charging Handle



-M3 Grease Gun Proto



-MP18 Proto (slightly different drum)



-EX-Pro OM (Metal pin for barrel)



ASSAULT RIFLES:

-AC8 V2





•V3



•OM (Only some were produced for a convention. Ultra rare)



-AKS-74u OM (the first version released in this specific color combo, pre-Clippy Day 13)



-Buzz Gun V1 (From Gears of War, predeceasing the HSR)



•V2



-L85A1 OM (WW item)



-M16-GL (First Proto for the M4-GL)



-M16-GL Candy Print





-M16 V1 (Shorter barrel)



-M16 w/ Flamethrower



-M16A2 V1



-M16A2 V2



-M16A2 OM



-M27 IAR (No Grip) (Considered a V1)



•V1 OM



•No Optic (Scope undermolds snap off cleanly, according to Will)



-HAC OM





-M4 ARC Proto



•w/ Grip (Obvious why this didn't make it to full production)



-ARC V2 Proto



-M4-TAC Reloaded Remix (CB limited event)



•Non-OM (Went with a fig)



-M41A Pulse Rifle V2 OM



•V1 OM(?)

-SARK (From Halo, based off the books. A convention item or an item from a Contributor Pack)



-Joint Force Long Rifle (Loosely inspired by a weapon from Deus Ex, a suppressed FR-27))



•OM (Only a few made by Floodllama)



-Joint Force Sci-fi Rifle (Inspired by concept art)



-Coreburner OM (Like the Combat PDW, cut-off parts placed into a mold for a one-time use)



-AR-W1K V1 "Ribs" (Would not inject cleanly)



•V2 "Keymod" (Would not inject cleanly)



-XBR4 Proto (No muzzle piece, making the barrel slightly shorter)



-XBR4 Wireframe (Originally from G.I. Brick)



•Test Print



-M4 TAC OM



-M4 SBR OM (Part of Modcom Fused back in the day)



-D9-AR Proto and OM (Spikes were glued, no front sight)



-Scoped Morita Carbine



-AK-NDR OM



-AK-NDR w/ Stock and Optic



-M16A2-GL V1



-Corpo Modular Rifle

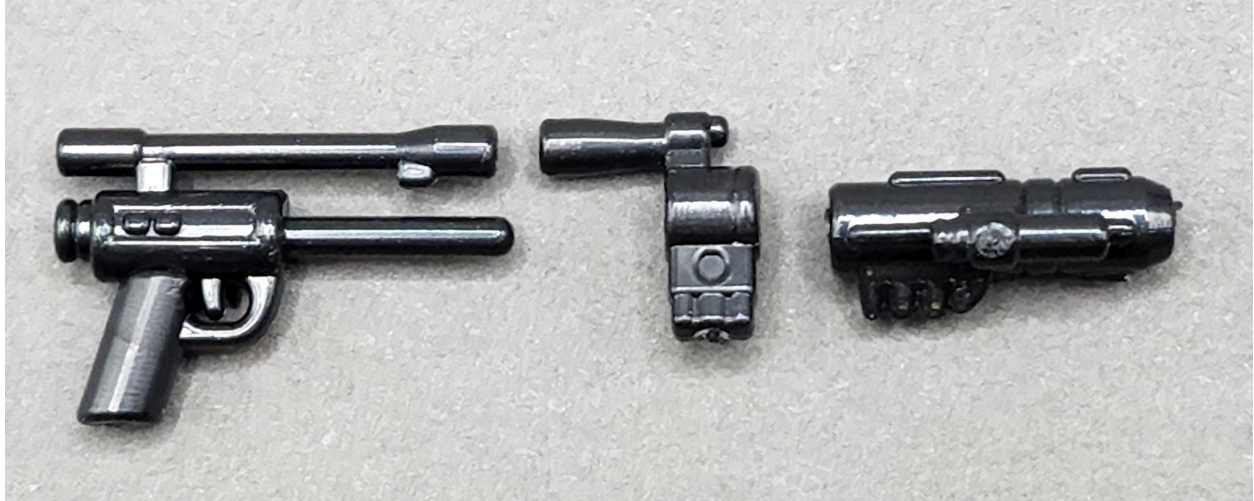

-AK-Specter V2



-AK-Specter V3 (Left)



-AK-Romy V1 (Less detail)



-AK-Romy Underfolder



-AK-FS



-AK-FS Tactical



-AK-Katya



-AK-105 V1



-AK-74U Faina



-AK-74U FS



SNIPER RIFLES:

-M1903 USMC Sniper OM



-M1904-A4 Sniper OM



-MK-M Sniper Blaster OM (WW item, based off of Fennec Shand's blaster from Star Wars)



-XSR (Based off of the SRS99D-S2 AM from Halo 4. Only obtainable through the Sci-Fi X pack and some WW drops. Had a scope either glued on or just attached, plus a movable bipod that clips on)



-HCSR Proto (Different muzzle break)



-HCSR OM

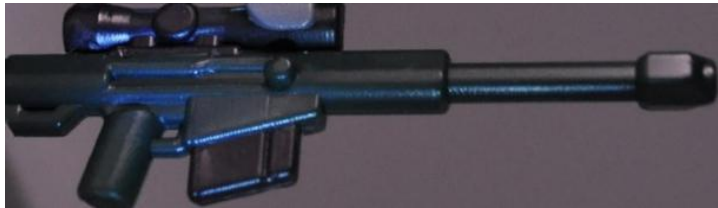

-773 Firepuncher V1

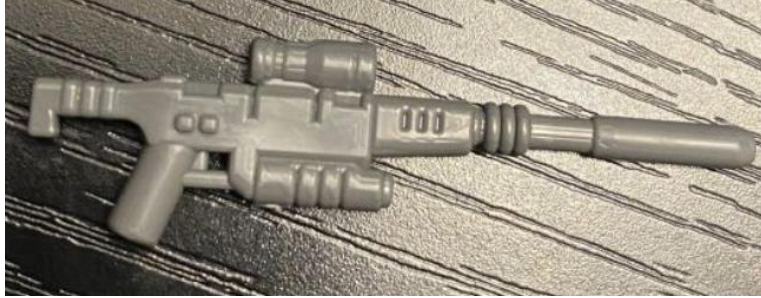

•V2



-M110 SASS Proto (Longer and had a thinner suppressor)



-Galactic Gunfighter Rifle w/ Big Stock



SHOTGUNS:

-Bonejack (Had to have three parts glued together: the receiver, barrel, and muzzle. From the Marvel comic "Blade", it's a lever-action wooden stake launcher used for killing vampires)



-M97 Trench Gun w/ Bayonet



-M97 Trench Gun OM



-Sawed Off Shotgun V1 Proto



•OM



-RAT V1 (Based on a mod someone made that Will liked, similar to the origin of the BAR-42)



•V2



-XMS V1 (Based off of the M90 shotgun from Halo)



•V2



•V3



-ACS Proto



-ACS Candy Print





-Modular Shotgun Non-OM



MACHINE GUNS:

-Bren Proto



•Proto OM



-F3F Machine Gun (Based off of the Conduit F3 from Destiny. Wasn't released due to Will saying it "didn't gain much interest")



•OM



-DLT-19 OM (Workshop Wonder)



-DLT-19D OM (Workshop Wonder)



-DLT-19X OM (WW)



-M1909 Hotchkiss Mk1 Stockless



-M1917A1 Proto



-DShK V1 (One piece)



-Chrome M1917A1



-MG-34 Reloaded Non-OM



-MG-34 Proto



-Minigun Proto (Barrel and receiver were one piece that was a pain to inject)

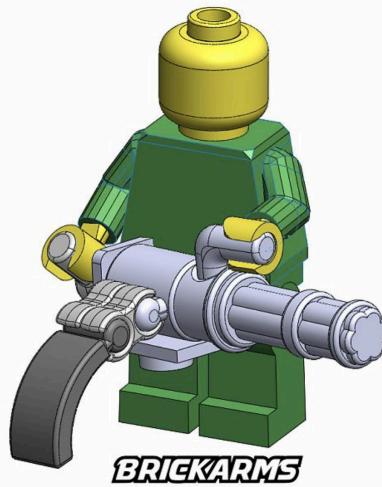



-MPC (Will said it wasn't meant to be a Halo weapon, but the community thinks of it as the Jorge Chain Gun)



-PKT (Obtained from BKM's 2S3)



-XM345 Overkill OM (Based off the BTRD-345 from Destiny)





-M2HB 24k (Charity item)



-EW-10HB Cannon 1



-EW-10HB Cannon 2



-M240B USMC (No PEQ Box)



-PKM (No skeletonized stock)



-PKP OM



-Kalashnikov Variants (for a Discord contest)



•KB-F Stockless



•KB-F Non-OM



-RPD without ammo slot



-RPK w/ Bipod



-RPK OM



-RPK-74M Tactical Suppressed



-M249 SAW Para OM



-Z6 Rotary Cannon Proto (different barrel)



-M1919 Proto (No heat shield)



-Lewis Gun V1



-Lewis Gun V2



-M2HB Proto



EXPLOSIVE / NON BULLET:

-Bangalore Torpedo (BKM set exclusive)



-Cannon Balls



-Cannon Ball



-Cannon Ball "OM" (Two pieces)

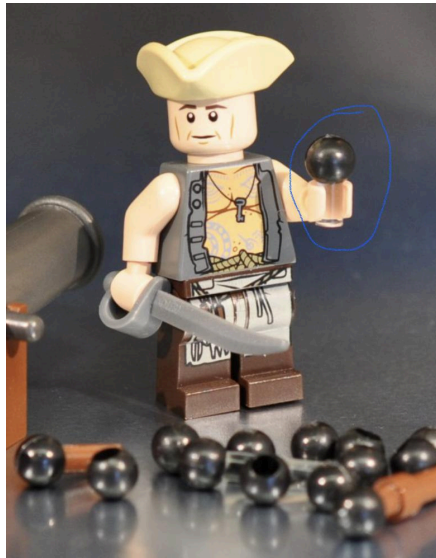

-Swivel Gun V1 (larger with different barrel detailing and a different handle piece.)



-D93 Incinerator and Backpack OM





-Howitzer Shell Proto



•OM



-HE Round Proto



-Le Prieur Rocket



-HLC-V1 (Based off of the ARASAKA HLR12X from Akira. Had a tolerance issue)



•Prior Version (No scope, less details, and shorter)



-M2 Flamethrower V1



•V2



•V3



•V0



-M79 Bloop Gun V1



•V1 OM



•V2 OM



-Mini Nuke V2 (Made for presumably Fallout. Top insert can be swapped out)



•OM Head



-Mini Nuke V1



•Non-OM



-24k Gold Mk19 Grenade Launcher (Charity item)



•Chrome Silver

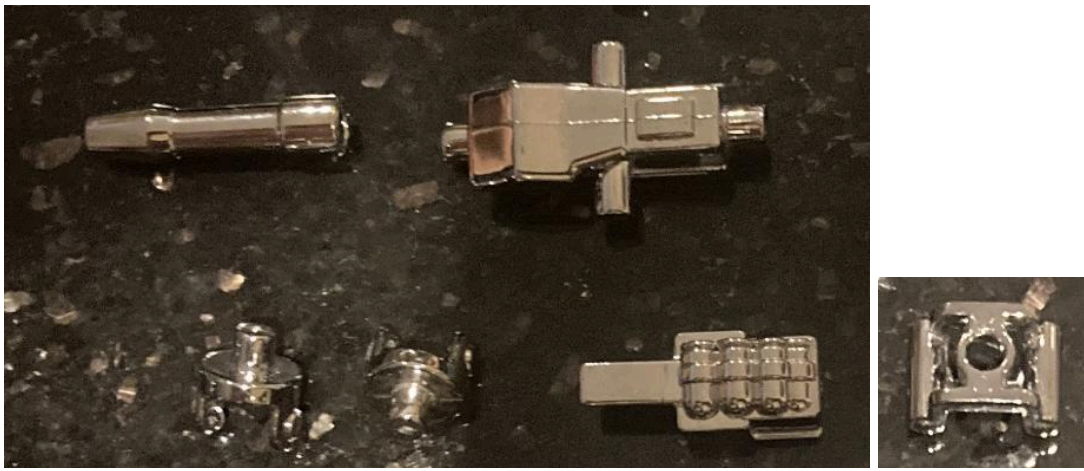

-Mortar Shell V1 (For the Japanese knee mortar)



•V2



•V3



-Bofors 40mm Clip OM (Obtained through the Brickmania M42 Duster Kit)

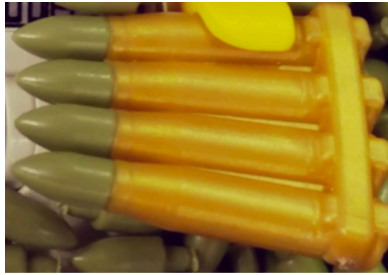

•2-round



-Panzerschreck (Pack-Exclusive)



•Panzerschreck Rocket



-Rocket Pistol V1 (Based off the M363 from Halo)



•V2



•V2 Non-OM



-Heavy Laser (Based off of the Spartan Laser from Halo)



•Non OM



•Rubber OM

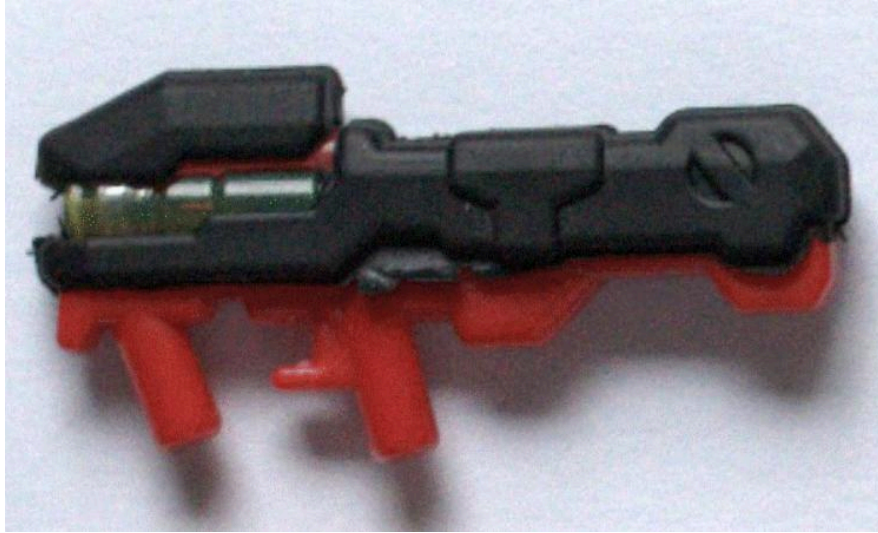

-XRG OM (Based off of the ARC-920 Railgun from Halo)



-XRG Wireframe



-XM41 (Based off of the M41 SPNKR from Halo)



•Aluminum Pipe OM



•Brass Pipe OM (Result of Will experimenting with different alloys to overmold. Ultra rare.)



-Joint Force Shock Cannon (Based off of the Brute Mauler from Halo)



-Japanese Knee Mortar V1 (Fragile; Cracking issues)



•V2



-Knee Mortar Grenade



-Mk82 (Will made the mold with probably the intentions of a BKM set, however didn't take the design any further. Enigmabadger also said that it was a nightmare to inject due to the size, studs, and the use of pins)



-MGL Proto (No stock and scope)



-40mm Grenade OM (Revealed alongside of the Reloaded M79 Bloop Gun)



-RPG-7 Warhead without metal pin



-Mando Mortar



-ZLT-10 V1 (No peg on undermold, foregrip can snap off easily).



-M79 Pirate Non-OM



-M24 ATG



•Non-OM



MELEE:
-Bat Spikes



•Plastic



-Combat Knife OM



-Cimmerian Axe Head



-Cimmerian Axe Proto



•OM



-Damien Blade Proto V1



•OM

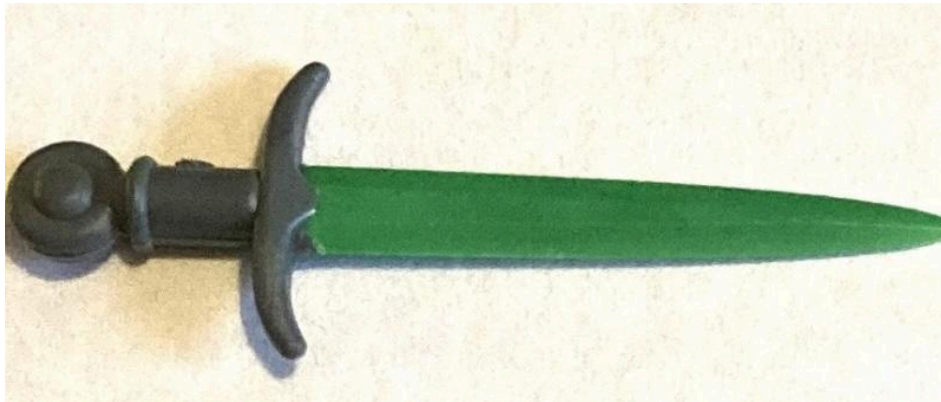

•V2



•V3

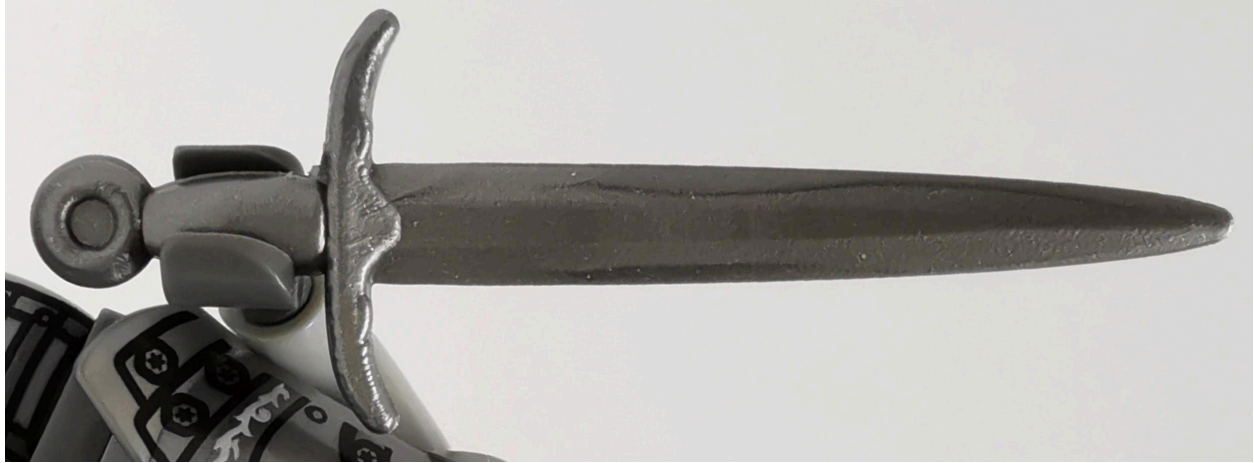

-Entrenching Hatchet 1



•OM



-Entrenching Hatchet 2



-Tomahawk Proto



•Non-OM



-Halberd



•OM



-Halberd Head



-Kukri Proto



•OM



-Naginata



-Nail Bat



-Nunchucks (Went with a fig or sold at a convention)



-Non-OM

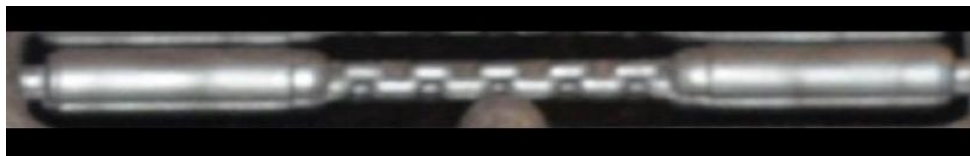

-Munchkinbricks Unnatural Axe (Part of a set of accessories from a game)



•Crazybricks Trademarked



•Sparkly Proto (for a special event)



•OM



•24k / Chrome OM



-Plasma Blade OM (Based off of the Energy Sword from Halo)

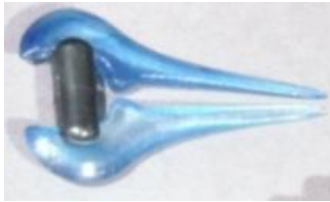

-Trench Mace V1 OM



-Tactical Sword Proto (Shorter than the production variant)



-Battle Axe OM (For a convention)



-GAMO Cleaver V1 (Circled)

-GAMO Cleaver Non-OM (Not the circled one)

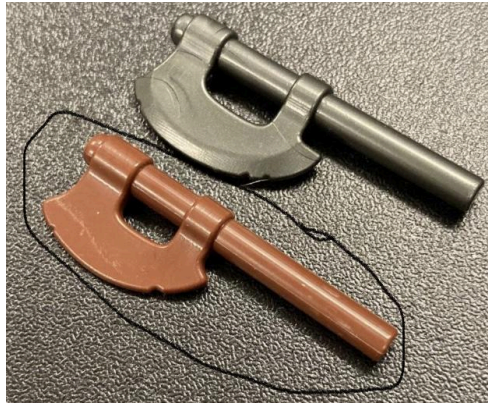

•Special Version

 [@302_bricks](#) I saw this on the BC drop link. Is this a V2?



BrickArms Today at 11:31 PM

Looka like I clipped the haft of a Dark Warriors Axe, and overmolded the blade onto it instead. I like to mix it up.



-GAMO Hatchet Non-OM



-GAMO Short Sword Non-OM



-GAMO Hatchet Head



-GAMO Cleaver Head



-Modded GAMO Axe



-Claymore OM



-Vibroblade (Based off of the weapon from the Madalorian)



-Butterfly Knife (Open) OM



-Butterfly Knife (Half Open) OM



-Machete Proto (No bottom ridge on the handle)



-Machete OM



-Hanger Sword Early Design



•V1 (larger than the current one)



•V1 OM



-Dark Warrior Cleaver OM



-Dark Warrior Mace OM



-Dark Warrior Axe OM

Handmade Injection



-Dark Warrior Scythe OM



-Dark Warrior Knife OM



-Havoc Blade Proto (no grip texturing)



WEARABLES:

-Classic Medical Scanner



-Unnamed Pouch



-Star Wars Vest Pouches (Had to glue to the vest)



-First Order Vest (Had to glue to the minifig)



•OM



-First Order Vest Proto



•Proto OM



-Flame Trooper Vest



-First Order Stormtrooper Vest



-Modular Vest (3D-Printed Vest with ABS attachments. Was the first development of BA bodywear and wasn't satisfactory for Will.)



-US Rifleman Web Gear Proto



-US Ranger Web Gear Proto



BARRELS:

-Tri-Barrel Assembly (WW item. Badger said that Will has been tuning the design for years. Multiple parts. Two different variants: one with thinner barrels and one with a different base connector).



-Cannon Barrel



MISCELLANEOUS:

-20-Round Magazine (Originally for the M110 SASS)



-20-Round Magazine (For the M16)



-30-round Magazine Proto (thicker bullet at the top)



•No bullet



-Bren Proto Mag



-Canadian Leaf (Given out at a convention)



-Drum Mag (For the PPSH Proto)



-Hacksaw OM (Still in it's testing phase)



-Proto U-Clip (Too brittle; Broke easily)



-Medkit (Came with a fig)



•Chrome Version



-Boom Box



-Micro Joes (Given out at a convention):

•Plane



•Submarine



•Tank



•Tanker Truck



•OM



-Sci-fi Ammo Box (Result of Will just messing around in AutoCAD)

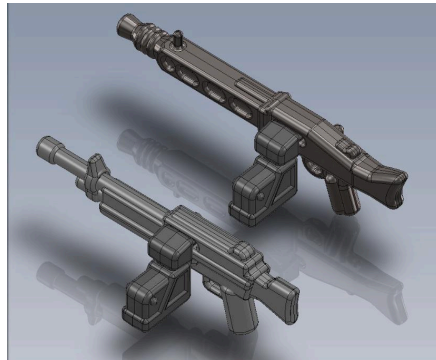



-Shotgun Shells



•Non OM



-Stapler (Went with a Citizen Brick fig)



-Tattoo Gun (Went with a Citizen Brick fig)



-Tattoo Ink Bottles



•OM



-Time Bomb V1



•V2

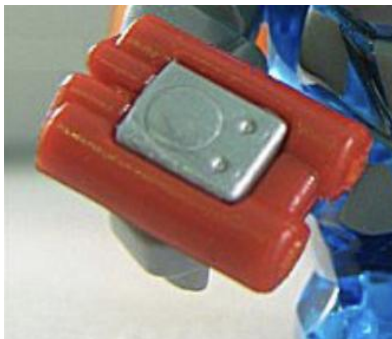

-20mm Round Proto



-TRON Disc



•Donuts



-Gingerbread Head (For CrazyBricks)



-Quantum Spanner (Sonic Screwdriver from Dr. Who)



•Non-OM



-Voight-Kampff Machine



•OM



-Zapper (Based off the NES Zapper)



*Non-OM



-BA Printed Stanley Case



-Combat LMG Ammo Box (Couldn't be taken off)



-MG34/42 Crate Insert



-M1919 Crate insert

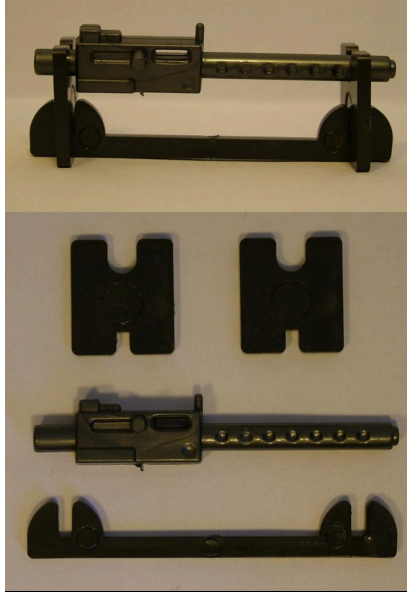

-Maxim Shield (Never made it out of the workshop)



-Nails (For the Nail Bat....never sold separately outside of WW's)



-Nails Proto



-U-Ring



-40mm Belt



•Non-OM



•Plastic

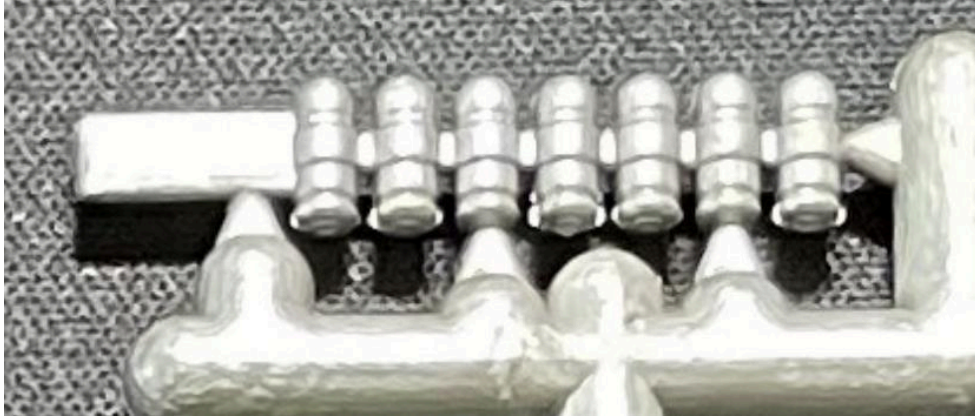

-Micro-Nuke Belt (For the Mk19)



-Artillery Shell Primers



-Tripod Pegs



-ACS Holder



-ACS Holder (No Drum)



-Laser-Cut Badger Jig



-Laser-Cut Acrylic Torso Cutout (From a template Will created to print on torsos.)

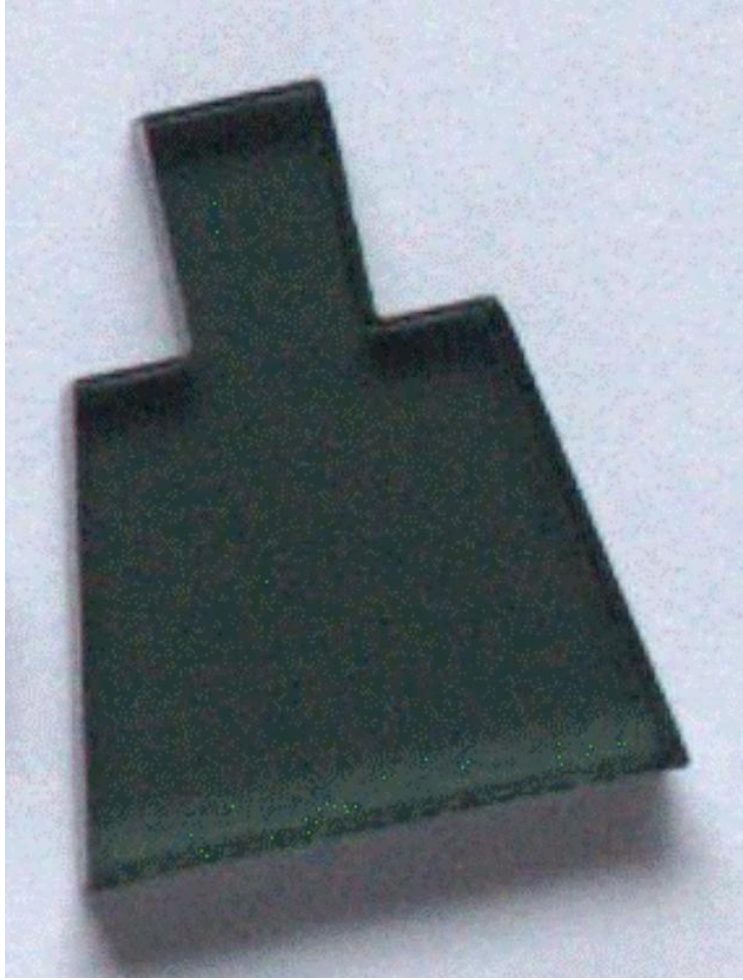

-MG-08 Case



-Ball Clip



-Barbell 4S



-NATO magazine OM



-M203 V1 (Could not universally fit on all BA)

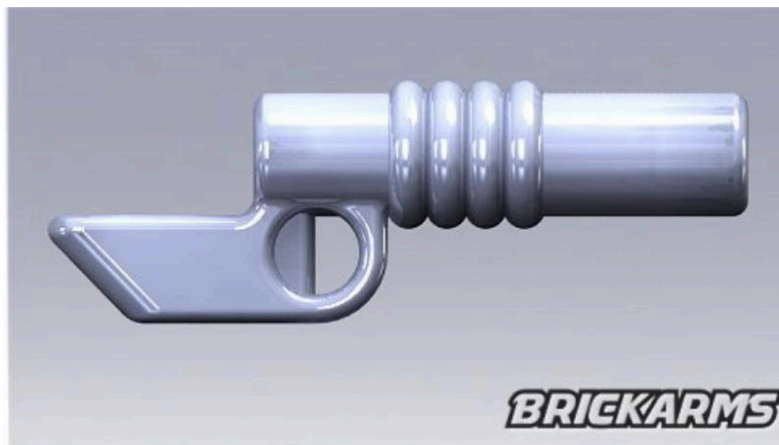

-Bofors 40mm Shell Clip Proto (Different detailing in between each shell)

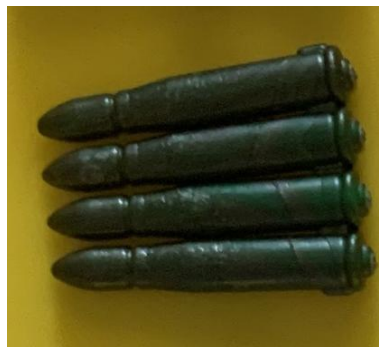

-Ammo Tray V1 (Thinner and longer than the one that is mass produced)



-Minigun Handle Proto



-Paintball Marker V1



-BA Piggy Bank



-Long Rubber Feed Chute with tab and pin



-U-Scope V1



•V2



-Ammo Belt Proto (too brittle)



-EX-Pro Suppressor (Made of either rubber or plastic)



-Cyclone (April Fools 2023 release. Is compatible with Modcom.)



-Tactical Cyclone



•Non-OM



-EW-10HB Battery Pack and Cable

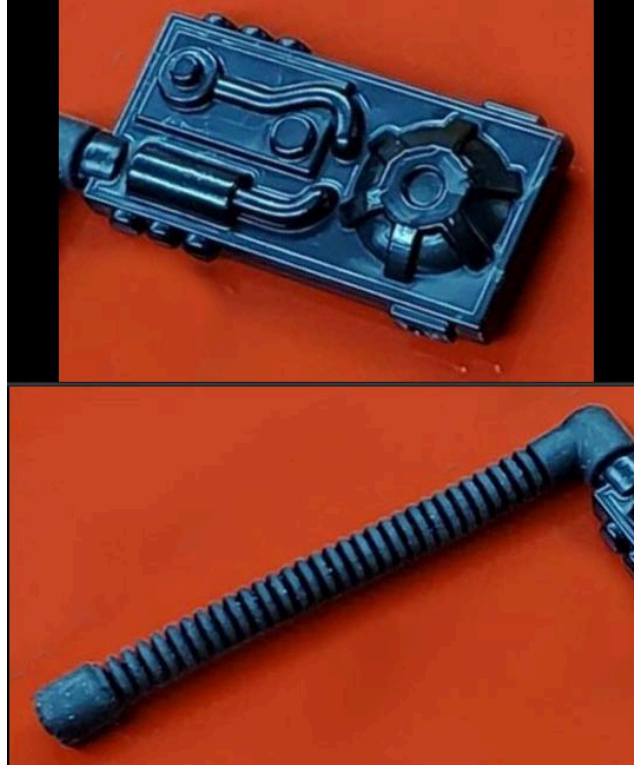



MODCOM / MODULAR:
-Any MODCOM Component





-E-11 Scope



 **@302_bricks** Is this a modcom SW scope?

 **enigmabadger** Today at 8:53 AM

Sort of! It goes all the way to Will's first explorations of an E-11-inspired design. Been too many years for me to remember exactly, but I think the thought was to possibly make the scope removable to the accessory could work as both an E-11 and a Sterling SMG-type item. The concept was abandoned pretty quickly

 1 

-Railfail



•OM



-Railfail Grip (Was easy to break and prone to stress marks.)



•Regarding other attachments:

 **@Plastic Man** Were there any other attachments for the Railfail?



enigmabadger Today at 9:01 AM

I recall the grip being the only one. At the time, Will mentioned scopes and/or a M203 launcher as being possibilities, but I don't believe they were ever designed or prototyped.



-MODCOM Fused-Hartford



•OM





•Second Version



•Plain Barrel



OTHER:

-Chrome Colors that are not Gold or Silver:



-Any BA that was printed by Will (Often in packs)



•Prints on 24k Gold-Plated BA's



-Full-Metal BA (Only in Will's workshop)

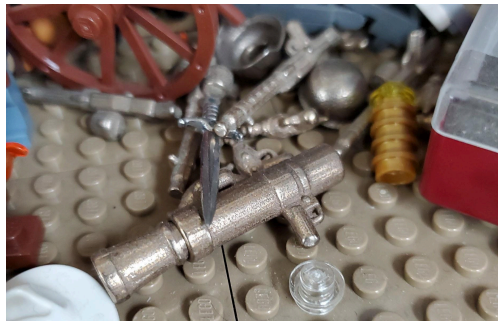

-Solid Gold BA (Made by a dentist for Will. They remain in his workshop.)



-Entire Sprue of 24k Gold-Plated AK's



-Entire Sprue of 24k Gold-Plated Series 1 BA



-“Proto Poo” (yes...seriously. It’s the result of Will letting excess plastic run out of his CNC machine)



-BA Dog Tag



-BA Official Shirt



-Brickarms Coins



-5-Year Anniversary Coin



-BA Pirate Flag



SUPERSIZED BRICKARMS:
-Mosin Nagant



-Claymore



-M2HB



"This is my fight face" -Lando

-Needle Gun "OM"



Dual-wielding at WWB Hartford

-Needle Gun



-Mk2 Grenade



-Hand Cannon



-MODCOM....thing

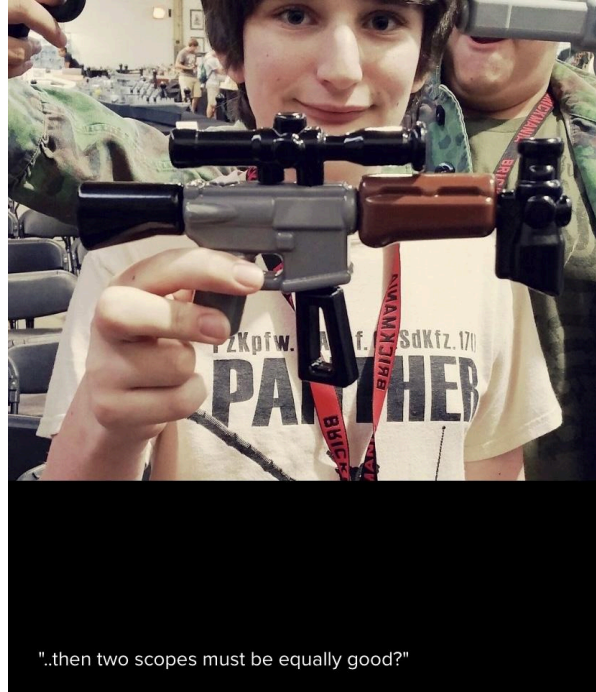

"..then two scopes must be equally good?"

-Trans Clear Retro Ray Gun



-Trans Orange Retro Ray Gun



-XMS



-Trans Neon Green Flintlock Pistol



-DL-44

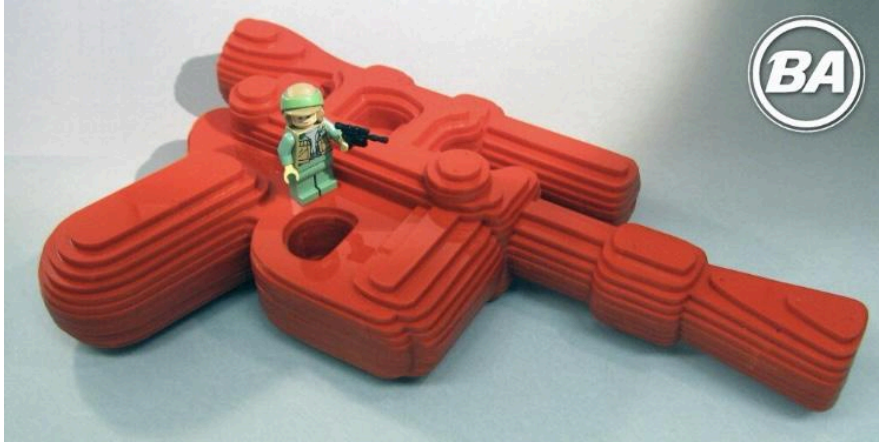

-Unnatural Axe "OM"



-M110 SASS



-Battle Axe



-M1911 "OM"



-Desert Eagle

